

**alberta**<sup>®</sup>  
The first name in Italian sofas

The first name in Italian sofas

SUMMER TIME

# SUMMER TIME



alberta

The first name in Italian sofas



## COMPANY PROFILE

Il marchio ALBERTA da trent'anni rappresenta garanzia di qualità nella progettazione e nella produzione di divani e poltrone. L'azienda opera nel trevigiano, nord-est Italia, dal cui substrato culturale ha attinto sia la tradizione artigiana sia l'attitudine alla creatività ed al design. Nel corso della sua storia ha sviluppato nei diversi stabilimenti linee di imbottiti sempre rispondenti all'evoluzione del gusto nelle due divisioni base che raggruppano le collezioni in tessuto e quelle in pelle. L'esperienza nell'impiego di entrambi i materiali consente ad Alberta di essere altamente propositiva. L'obiettivo dell'azienda è offrire soluzioni originali di ottimo livello estetico, pratico e qualitativo nel rispetto dei principi dell'etica ambientale.

*For thirty years the ALBERTA brand has been recognized as a guarantee of quality in the design and production of sofas and armchairs. The company is headquartered in the Province of Treviso in the north east of Italy and has taken both its tradition of fine craftwork and its passion for creativity and design from this stimulating and active land. In order to meet the needs of ever-changing tastes the company has developed and now manufactures an extensive range of products based on two basic divisions, their textile and leather furniture collections. The experience they have gained working with these materials enables Alberta to be proactive and continually develop new solutions. The company mission is to create original products which combine great looks with practicality and quality while ensuring the utmost respect for the environment.*

*Die Marke ALBERTA steht seit dreißig Jahren als Garantie für Qualität in der Entwicklung und Herstellung von Sofas und Sesseln. Das Unternehmen hat seinen Hauptsitz in der Provinz Treviso, im Nordosten Italiens. Angeregt von dieser Kultur und Landschaft schöpft Alberta sowohl aus der handwerklichen Tradition als auch aus der Begabung und Leidenschaft für Kreativität und Design. Im Laufe seiner Geschichte hat das Unternehmen in seinen verschiedenen Betrieben eine breite Palette von Polstermöbel entwickelt, die den Bedürfnissen der Kunden entgegenkommt. Dabei sind zwei grundlegende Richtungen entstanden: die Stoff- und die Lederkollektion. Die gewonnenen Erfahrungen in der Verwendung mit beiden Materialien ermöglicht Alberta sehr aktiv zu sein und ständig neue Lösungen zu entwickeln. Das Unternehmen hat sich zum Ziel gesetzt, originelle Lösungen mit hohem ästhetischen, praktischen und qualitativen Niveau anzubieten und gleichzeitig umweltfreundlich zu sein.*

*Le marque ALBERTA depuis 30 ans c'est une garantie de qualité dans la projection et fabrication de fauteuils et canapés. L'usine opère dans la province de Treviso, nord-est de l'Italie, et du substrat culturel de cette zone elle a pris soit la tradition artisanale soit la disposition à la créativité et au design. Au cours de l'histoire elle a développé dans les différents usines des lignes des canapés toujours correspondant à l'évolution du goût dans les deux collections en cuir et tissu. L'expérience dans l'utilisations des matériaux a permis à Alberta d'être bien propositive avec ces collections. L'objectif de l'usine est offrir solutions originales de niveau esthétique, pratique et qualitatif excellent dans le respect des principes de l'éthique de l'ambiance.*

# SUMMER TIME



**Modello composto da elementi con diverse profondità**  
*Model composed of elements with different depths*  
*Modèle composé par éléments de différentes profondeurs*  
*Modell mit Elementen aus verschiedenen Tiefen*





















# SUMMER TIME















**Con l'utilizzo dell'angolo profondo dx (o sx) è possibile creare composizioni con due profondità: un lato standard, un lato profondo.**

*With the deep corner right (or left) it is possible to make compositions with two depths: one side standard, one side deep.*

*Avec l'angle profond droit (ou gauche) il est possible faire compositions avec deux profondeurs: une côté standard et une côté profonde.*

*Mit der tiefen Ecke rechts (oder links) ist es möglich, ein Kombination mit zwei Tiefen zu machen: eine standard Seite, eine tiefe Seite.*



















# SUMMER TIME































# disegni e descrizioni tecniche

*drawings and technical descriptions*

# descrizioni tecniche

*technical descriptions*



Struttura portante in massello di legno, rivestita in vellutino di poliammide. Molleggio realizzato con molle di tipo Nosag. Cuscino di schienale in piuma d'oca e poliuretano espanso rivestito con fodera di cotone, cuscino di seduta in piuma d'oca e poliuretano espanso rivestito con fodera di cotone.

*Main structure in solid wood, covered with a polyamide thin velvet. Springing system through Nosag springs. Backrest cushion in goose feathers and polyurethane foam covered with cotton covers, seat cushion in goose feathers and polyurethane foam covered with cotton covers.*

*Structure principal en bois massif sous housse de polyamide. Suspensions réalisé avec ressort Nosag. Coussin de dossier en plumes d'oie et polyuréthane expansé sous housse de coton, coussin d'assise en plumes d'oie et polyuréthane expansé sous housse de coton.*

*Tragstruktur aus Massivholz in samtigem Polyamid verkleidet. Federung bestehend aus Nosag Riemen. Rückenkissen aus Gänsedaunen und Polyurethanshaum, Abgedeckt mit Baumwolle; Sitzkissen aus Gänsedaunen und Polyurethanshaum, Abgedeckt mit Baumwolle.*



**0SMRC5 – CQ55SCP40 – CQ45SCP40**

Pelle composizione / Composition leather / Cuir composition / Komposition Leder  
962 Feeling, cat. G

Cuscinetti optional / Optional pillows / Coussins optionnels / Kissen optionelle  
962 Feeling, cat. G



**C1STSM – CLG99 – 5 CQP99**

Tessuto composizione / Composition fabric / tissu composition / Komposition Stoff  
523O Akim bianco, cat. 5

Cuscinetti optional / Optional pillows / Coussins optionnels / Kissen optionelle  
523O Akim bianco – 524H Akim piombo, cat. 5



**0SMRC6 – 2 CQP99 | 2SMRD3MPR – 3 CQ55SCP40 – 3 CQ45SCP40**

Pelle composizione / Composition leather / Cuir composition / Komposition Leder  
954 Fjord, cat. G

Cuscinetti optional / Optional pillows / Coussins optionnels / Kissen optionelle  
954 Fjord, cat. G



**0SMMC12 – 2 199CQ65 – 2 CQP99**

Tessuto composizione / Composition fabric / tissu composition / Komposition Stoff  
310J Bavaro tortora, cat. 3

Cuscinetti optional / Optional pillows / Coussins optionnels / Kissen optionelle  
600D Linux grigio, cat. 6



**C4STSM – 199CQ65 – 3 CQP99**

Tessuto composizione / Composition fabric / tissu composition / Komposition Stoff  
600F Linux terra, cat. 6

Cuscinetti optional / Optional pillows / Coussins optionnels / Kissen optionelle  
600F Linux terra – 600A Linux greggio, cat. 6



**D3MSTSM – 2 CG99 – 3 CQP99**

Tessuto composizione / Composition fabric / tissu composition / Komposition Stoff  
600D Linux grigio, cat. 6

Cuscinetti optional / Optional pillows / Coussins optionnels / Kissen optionelle  
600D Linux grigio, cat. 6



**1SMMD3MPR – 3 199CQ80 – 2 199CQ65 – CQP99**

Tessuto composizione / Composition fabric / tissu composition / Komposition Stoff  
600A Linux greggio, cat. 6

Cuscinetti optional / Optional pillows / Coussins optionnels / Kissen optionelle  
600A Linux greggio, cat. 6

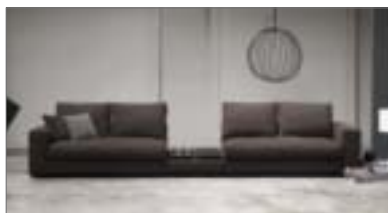

**C10STSM – 2 CQP99**

Tessuto composizione / Composition fabric / tissu composition / Komposition Stoff  
524G Akim terra, cat. 5

Cuscinetti optional / Optional pillows / Coussins optionnels / Kissen optionelle  
511Y Velvet topo, cat. 5 – 600D Linux grigio, cat. 6



# SUMMER TESSUTO | fabric | tissu | stoff

## COMPOSIZIONE / COMPOSITIONS / COMPOSITIONS / KOMPOSITIONEN

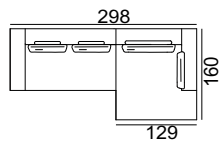

**C1STSM**  
(D2LSXSTSM-DORMDXSM)

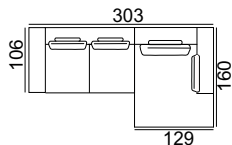

**C2STSM**  
(D2SXSTSM-DORMDXSM)

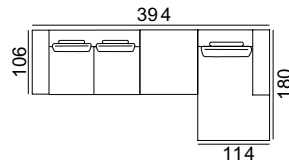

**C3STSM**  
(D2SXSTSM-POUFFQSM-DORMDXSM)

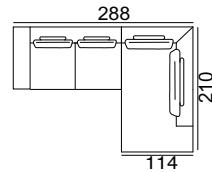

**C4STSM**  
(D2SXSTSM-MERDXSM)

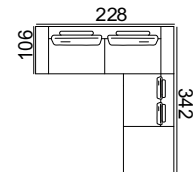

**C5STSM**  
(D2MSTSM-PCENJSTSM-POUFFQSM)

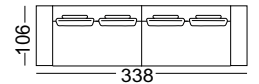

**C6STSM**  
(D2LSXSTSM-D2LDXSTSM)

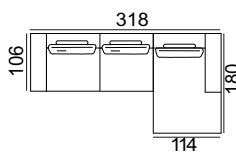

**C7STSM**  
(D2MSXSTSM-DORMDXSM)

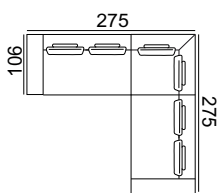

**C8STSM**  
(D2LSXSTSM-ARSTSM-D2LDXSTSM)



**C9STSM**  
(D3SXSTSM-EBVSTSM)

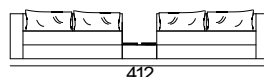

**C10STSM**  
(D2LSXSTSM-EVVSTSM-D2LDXSTSM)

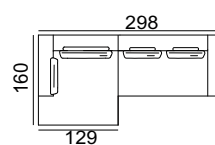

**OSMMC11**  
(DORMSXSM-D2LDXSTSM)

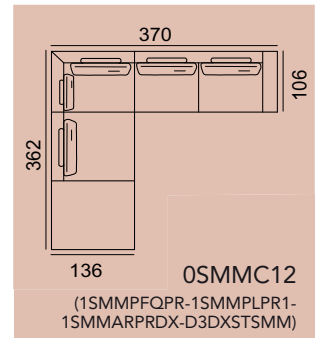

**OSMMC12**  
(1SMMPFQPR-1SMPLPR1-1SMARPRDX-D3DXSTSM)

## ELEMENTI / ELEMENTS / ELEMENTS / ELEMENTE

### STANDARD

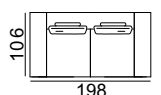
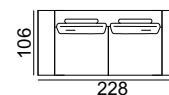
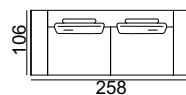
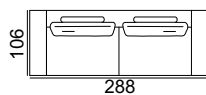
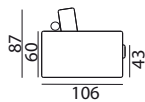

**D3MSTSM**

**D3STSM**

**D2MSTSM**

**D2STSM**

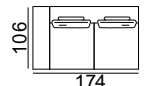
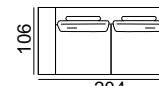
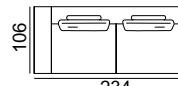
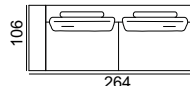
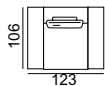

**PSTSM**

**D3MSXSTSM**

**D3SXSTSM**

**D2MSXSTSM**

**D2SXSTSM**

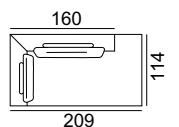
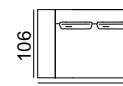
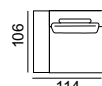
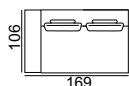

**D2LSXSTSM**

**PMSXSTSM**

**PSXSTSM**

**PSXJSTSM**

**MERSXSM**

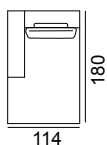

DORMXSXSMM

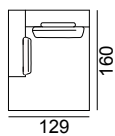

DORMSXSM

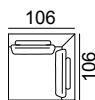

ARSTSMM



P1MSTSMM



P1STSMM

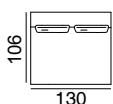

PCENJSTSMM



EBVSTSMM



EVVSTSMM

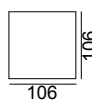

POUFFQSMM



1SMMCP75



1SMMCBR

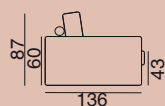

1SMMD3PR

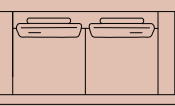
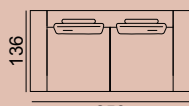

1SMMD3MPR

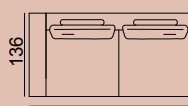

1SMMD3MPRSX

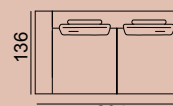

1SMMD3PRXS

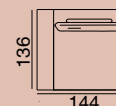

1SMMPLRXS

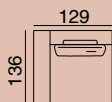

1SMMPMDPRSX

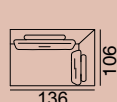

1SMMARPRSX

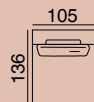

1SMMPMDPR1

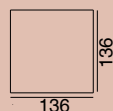

1SMMPFQPR

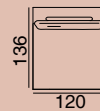

1SMMPLR1



1SMMCP75



1SMMCBR

**SUMMER** PELLE | leather | cuir | leder

COMPOSIZIONE / COMPOSITIONS / COMPOSITIONS / KOMPOSITIONEN

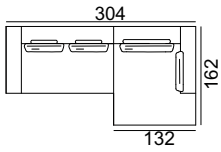

**OSMRC1**  
(2SMRD2LJDX-  
2SMRDORJSX)

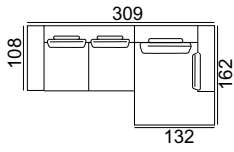

**OSMRC2**  
(2SMRD2SX-  
2SMRDORJDX)

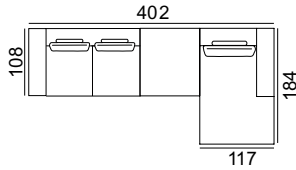

**OSMRC3**  
(2SMRD2SX-2SMRPFFQ-  
2SMRDORMXDX)

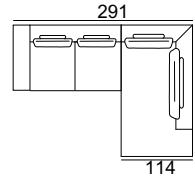

**OSMRC4**  
(2SMRD2SX-  
2SMRMERDX)

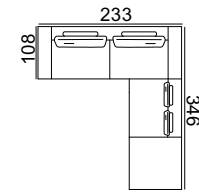

**OSMRC5**  
(2SMRD2M-2SMRPJ1-  
2SMRPFFQ)

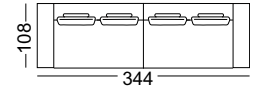

**OSMRC6**  
(2SMRD2LJSX-  
2SMRD2LJDX)

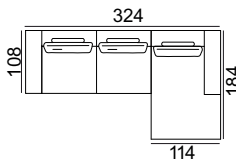

**OSMRC7**  
(2SMRD2MSX-  
2SMRDORMXDX)

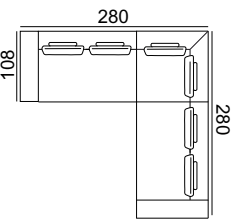

**OSMRC8**  
(2SMRD2LJSX-2SMRAR-  
2SMRD2LJDX)

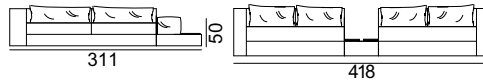

**OSMRC9**  
(2SMRD3SX-  
2SMREBV)

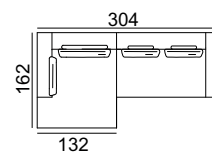

**OSMRC11**  
(2SMRDORJSX-  
2SMRD2LJDX)

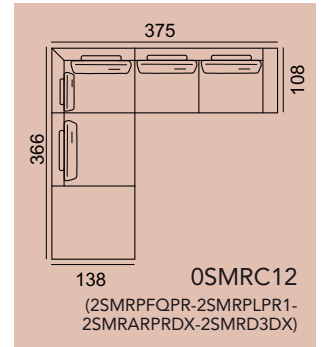

**OSMRC12**  
(2SMRPFQPR-2SMRPLPR1-  
2SMRARPRDX-2SMRD3DX)

ELEMENTI / ELEMENTS / ELEMENTS / ELEMENTE

STANDARD

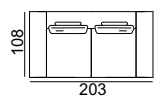
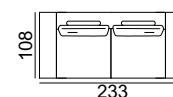
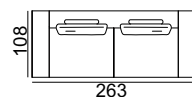
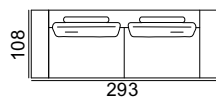
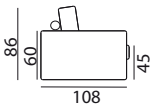

**2SMRD3M**

**2SMRD3**

**2SMRD2M**

**2SMRD2**

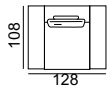

**2SMRP**

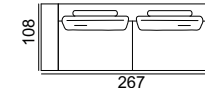

**2SMRD3MSX**

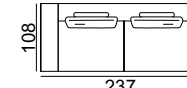

**2SMRD3SX**

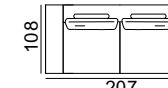

**2SMRD2MSX**

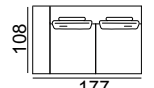

**2SMRD2SX**

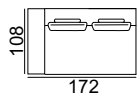

**2SMRD2LJSX**

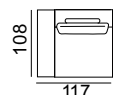

**2SMRPMSX**



**2SMRPSX**

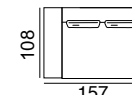

**2SMRPJSX**

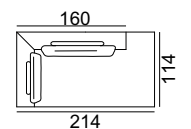

**2SMRMERSX**

**STANDARD**

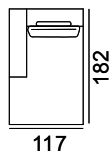

2SMRDORMXSX

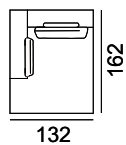

2SMRDORJSX

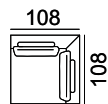

2SMRAR



2SMRPM1



2SMRP1

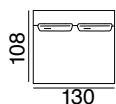

2SMRPJ1

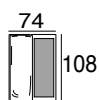

2SMREBV

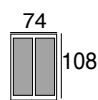

2SMREVV

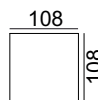

2SMRPFQ



2SMRCP75



2SMRCBR

**PROFONDO**

*Deep / Profond / Tief*

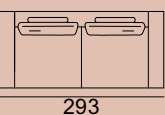
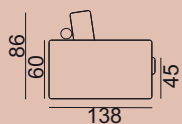

2SMRD3MPR

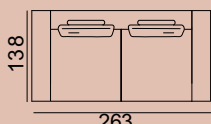

2SMRD3PR

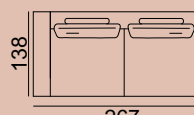

2SMRD3MPRSX

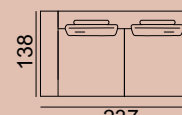

2SMRD3PRSX

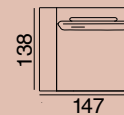

2SMRPLPRSX

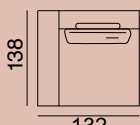

2SMRPM DPRSX

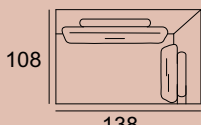

2SMRARPRSX

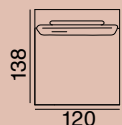

2SMRPLPR1

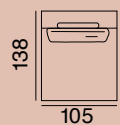

2SMRPM DPR1

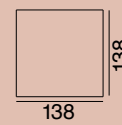

2SMRPFQPR



2SMRCP75



2SMRCBR

# SUMMER TIME







**alberta**<sup>®</sup>  
The first name in Italian sofas

La riproduzione totale o parziale è permessa esclusivamente su nostra autorizzazione.

Le immagini e i disegni contenuti nel presente catalogo sono puramente rappresentativi di questo prodotto e possono subire variazioni e modifiche anche senza preavviso.

Pertanto nella scelta degli articoli per la compilazione dell'ordine, fa fede solamente quanto contenuto nel listino in vigore.

*Reproduction, total or partial, is allowed exclusively under licence from our company. The photographs and drawings in this catalogue are only a representation of products and may be varied and changed without notice. When choosing article for your orders, only the details contained in the price-list in force should be considered.*

*La reproduction totale ou partielle est soumise exclusivement à notre autorisation. Les images et les dessins présents dans ce catalogue sont uniquement des représentations de ce produit et peuvent subir des variations et des modifications même sans préavis. Par conséquent, une fois les article choisis, lorsque vous remplirez le bon de commande, référez-vous au tarif en vigueur car il est le seul à faire foi.*

*Die Teilweise oder Gesamte Wiedergabe ist Ausschließlich mit unserer Erlaubnis gestattet. Hinweis: Alle in diesem Katalog enthaltenen Abbildungen sind unverbindlich; wir behaltenuns das Recht vor, Änderungen oder Verbesserungen ohne Ankündigung durchzuführen. Maßgeblich für die Auswahl der einzelnen zu bestellenden Produkte ist ausschließlich die jeweils gültige Verkaufspreisliste.*

Photo: Emozioni.com  
Renai&Renai

Supervision: The Independent Creativity Ltd  
Graphic development: Creartcom.it  
Art direction: Arch. Anna Iuliano

General Coordination: Ufficio Stile Alberta Pacific Furniture s.r.l.

Printed in Italy by: Grafiche Antiga

# alberta<sup>®</sup>

Alberta Pacific Furniture s.r.l.  
Via Toniolo, 41  
31028 Vazzola (TV) Italy  
Tel. +39 0438 440440  
Fax +39 0438 441555  
email: [contact@albertasalotti.it](mailto:contact@albertasalotti.it)

[www.alberta.it](http://www.alberta.it)

**alberta**<sup>®</sup>