

The first name in Italian sofas

the modern collection

02
2013

alberta[®]



The first name in Italian sofas



the modern collection

02

La **modern collection** accoglie ed esprime le più concrete ed attuali istanze del vivere lo spazio abitativo. Al di là della qualità che è un valore assoluto e dato per scontato, le parole chiave di questa collezione sono: design dalle linee pure, innovativo ed originale, personalizzazione attraverso una vera libertà di scelta ed interpretazione, garanzia di piacevolezza sensoriale e di comfort. Apriamo così il nostro ventaglio di soluzioni. Ed ognuno ci vedrà il proprio mondo.

*The **modern collection** embraces and expresses the most genuine, topical aspirations in modern interior décor. Along with quality, which is an absolute, foregone value, the key features of this collection are: innovative, original designs with clean lines; customisation assured by real freedom of choice and interpretation; guaranteed visual and physical comfort and pleasure. We open our treasure chest of solutions. Everyone will find their own world inside it.*

*La **modern collection** accueille et exprime les exigences les plus concrètes et actuelles de la manière de vivre la maison aujourd'hui. Au-delà de la qualité qui est une valeur absolue et qui va de soi, les mots clé de cette collection sont : design aux lignes pures, innovation et originalité, personnalisation à travers une vraie liberté de choix et d'interprétation, garantie de plaisir sensoriel et de confort. Ouvrons donc notre éventail de solutions. Et chacun y verra son propre monde.*

***Modern collection** ist eine Sammlung und ein Ausdruck für die konkreten und überaus aktuellen Ansprüche, die an modernen Wohnkomfort gestellt werden. Abgesehen von Qualität, die einen absoluten Wert darstellt und als selbstverständlich vorausgesetzt wird, sind die wesentlichen Merkmale dieser Kollektion: Design mit klaren, innovativen und originellen Linien, individuelle Gestaltung durch vielfältige Auswahl und Möglichkeiten der Interpretation, angenehme sinnliche Empfindungen und Komfort. So öffnen wir das breite Spektrum unserer Lösungen. Eine eigene Welt für jeden.*

alberta®

MOON STELLA	06
AVENUE	24
BEVERLY	36
LUNA	48
URBAN	56
DALLAS	64
NEWPORT	78
TOSCA	92
POUFF - MORBIDOSO 99 BABY	98
CUSCINI	110
disegni tecnici / <i>technical drawings</i>	116
descrizioni tecniche / <i>technical descriptions</i>	136
COMPANY PROFILE	140



MOON

eternal space



MOON



STELLA

movable relaxation



STELLA



STELLA



STELLA



STELLA | MOON



Profondità di seduta variabile | Changeable depth

STELLA



alberta.

Artigianalmente

Artisanal

L'arte del fare con le mani e gli strumenti seguendo il sapiente filo della tradizione. Tecniche antiche ed insuperate che realizzano creazioni avveniristiche.

Working by hand with tools from the tradition of the finest artisans. Ancient techniques never surpassed, still generating futuristic designs.



AVENUE

the road to elegance





AVENUE





AVENUE



alberta.



Confortevolmente

Comfortable

In quale altro luogo, se non il proprio divano, è possibile godersi esperienze impagabili come l'ozio, la lettura, la conversazione?

Where if not on your own sofa can you enjoy the unique, simple pleasures of reading, of conversation. Of leisure.

BEVERLY

refined detailing



BEVERLY



BEVERLY



BEVERLY



BEVERLY



alberta.

Tradizionalmente

Lavorazioni da bottega artigiana

Traditional
Crafted in an artisanal workshop



LUNA

a new frontier





LUNA





Materialmente

Material

Un'ampia scelta di tessuti morbidissimi e resistenti e pellami dalla qualità certificata ed indiscutibile come quella degli elementi invisibili come struttura ed imbottiture.

A broad choice of unbelievably soft yet resistant fabrics and leathers all with guaranteed, certified quality, the same standards we apply to all our internal structures and padding.

URBAN

metropolitan style



URBAN





alberta.

Cromaticamente

Colourful

La purezza del design accoglie il colore e lo esalta. È il primo passo verso la caratterizzazione dello spazio. La scelta è ampia e rigorosamente... libera.

Pure design that welcomes and intensifies colour. This is the first step towards making a statement in a space. The choice is vast and, of course, completely unrestricted.



DALLAS
modern high life

DALLAS



DALLAS





DALLAS



DALLAS



alberta

Contemporaneamente

Contemporary

Soluzioni contemporanee imposte dall'attualità del vivere: necessità di gestire lo spazio casa tra lavoro, relazioni e relax in un contesto esteticamente sempre raffinato ed originale.

Contemporary solutions for today's living: spaces that must adapt for work, family and relaxation while remaining aesthetically refined and original.

NEWPORT

wide open spaces



NEWPORT



NEWPORT



NEWPORT



NEWPORT



NEWPORT



alberla

Artisticamente

Artistic

L'arte del design come incontro tra creatività e praticità nella concezione moderna della casa. Collezioni attuali ed innovative pensate per essere reali e vivibili.

The art of design as a coming together of creativity and practicality in the modern concept of home. Modern, innovative collections designed to be genuine, and genuinely liveable.



TOSCA

soft elegance



TOSCA



alberta.

Interpretativamente

Interpretational

Libere interpretazioni ed espressioni del gusto personale. Un insieme in evoluzione e sempre originalissimo. Gli elementi di arredo sono strumenti per questa sinfonia.

The freedom to interpret and express your own personal taste. Combinations in constant evolution, always unique. Furnishings are the instruments in this symphony of home.





BABY



MORBIDOSO | 99 | BABY



MORBIDOSO | 99



alberta.

Luminosamente

Illuminating

Atmosfere di luminosa modernità in cui nulla interrompe il ritmo fluido dell'esperienza. Dai particolari all'insieme abbiamo chiara la percezione di uno spazio che si apre e si lascia vivere.

Illuminating, modern ambiances where nothing breaks the fluid rhythm of living. From the original detailing to the overall effect we never forget that your space should be open and above all, liveable.



CUSCINI





CUSCINI





disegni tecnici
technical drawings

alberla

MOON

Tessuto | fabric | tissu | Stoff



COMPOSIZIONI / COMPOSITIONS / COMPOSITIONS / KOMPOSITIONEN

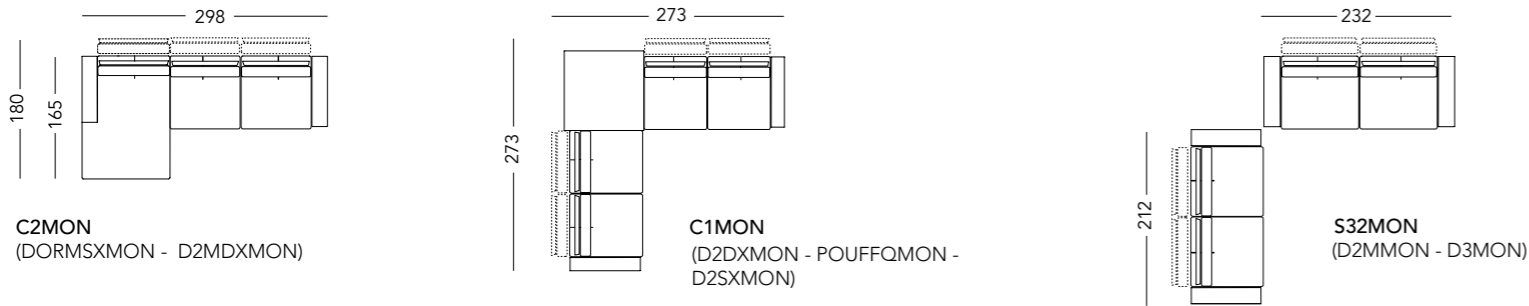

ELEMENTI / ELEMENTS / ELEMENTS / ELEMENTE

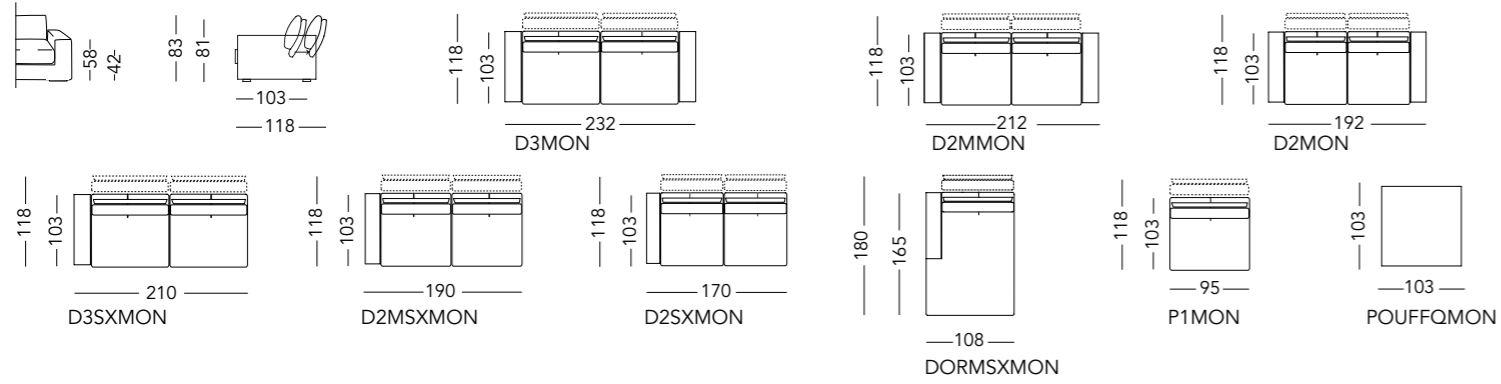

STELLA

Tessuto | fabric | tissu | Stoff

COMPOSIZIONI / COMPOSITIONS / COMPOSITIONS / KOMPOSITIONEN

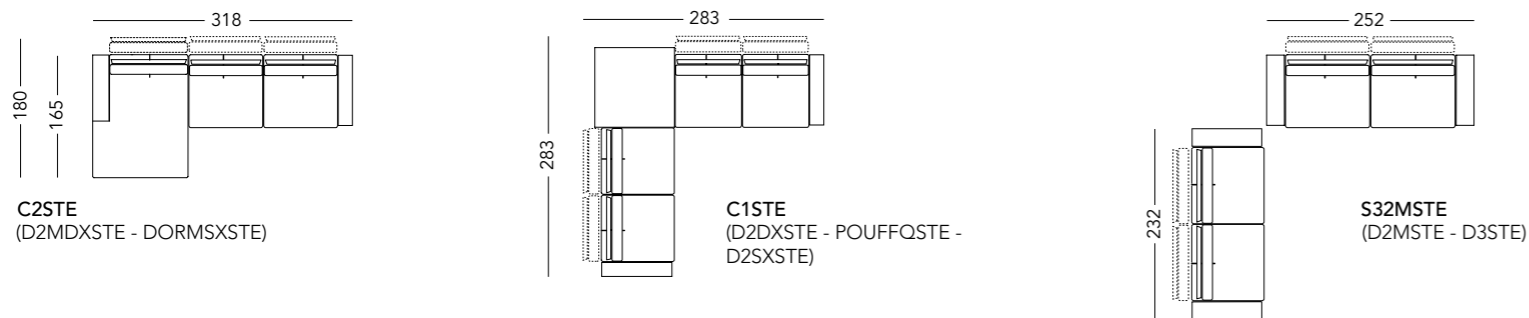

ELEMENTI / ELEMENTS / ELEMENTS / ELEMENTE

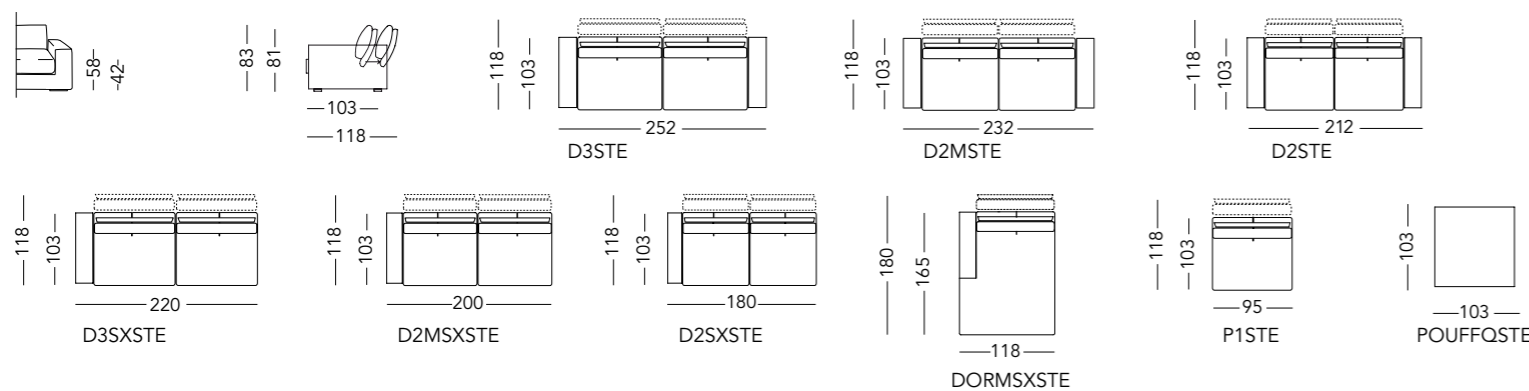

MOON

Pelle | leather | cuir | Leder



COMPOSIZIONI / COMPOSITIONS / COMPOSITIONS / KOMPOSITIONEN

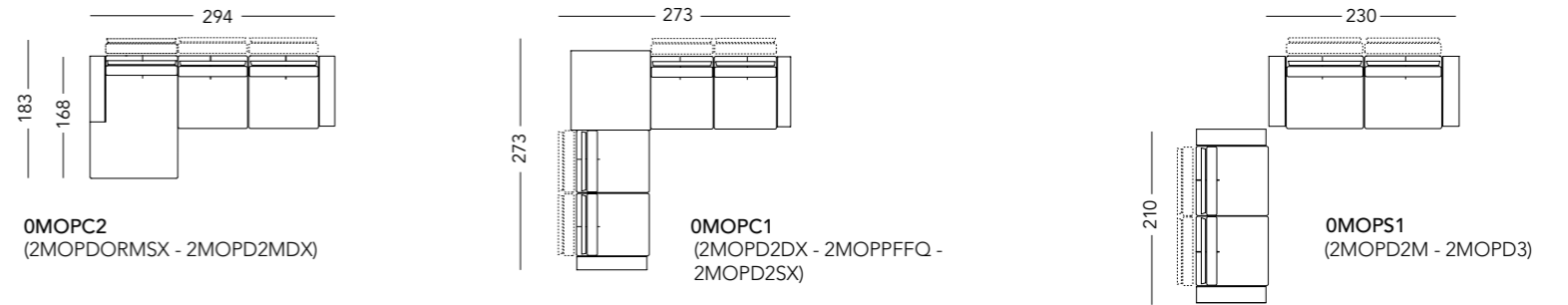

ELEMENTI / ELEMENTS / ELEMENTS / ELEMENTE

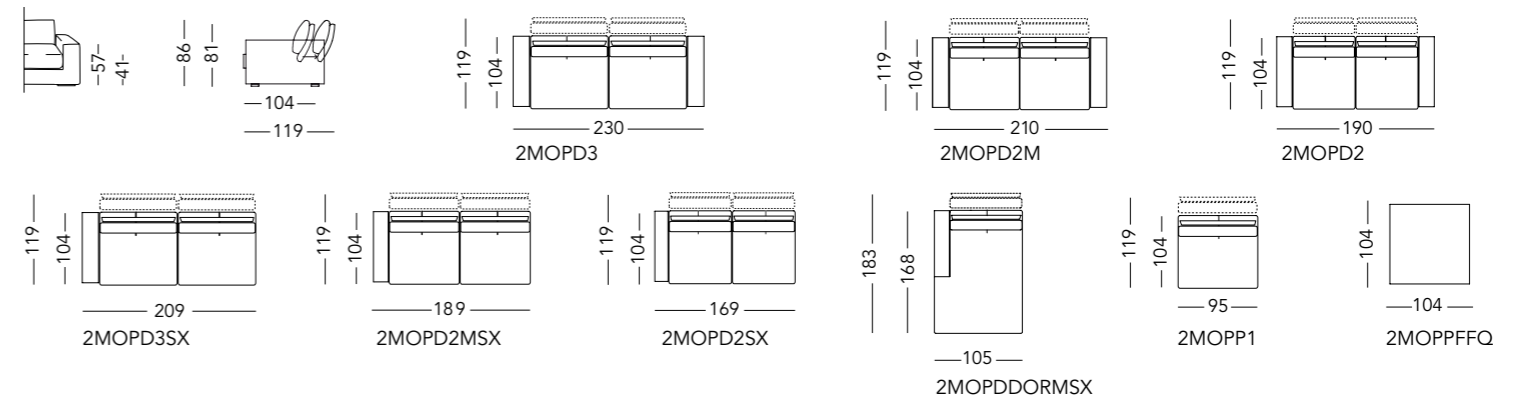

STELLA

Pelle | leather | cuir | Leder

COMPOSIZIONI / COMPOSITIONS / COMPOSITIONS / KOMPOSITIONEN

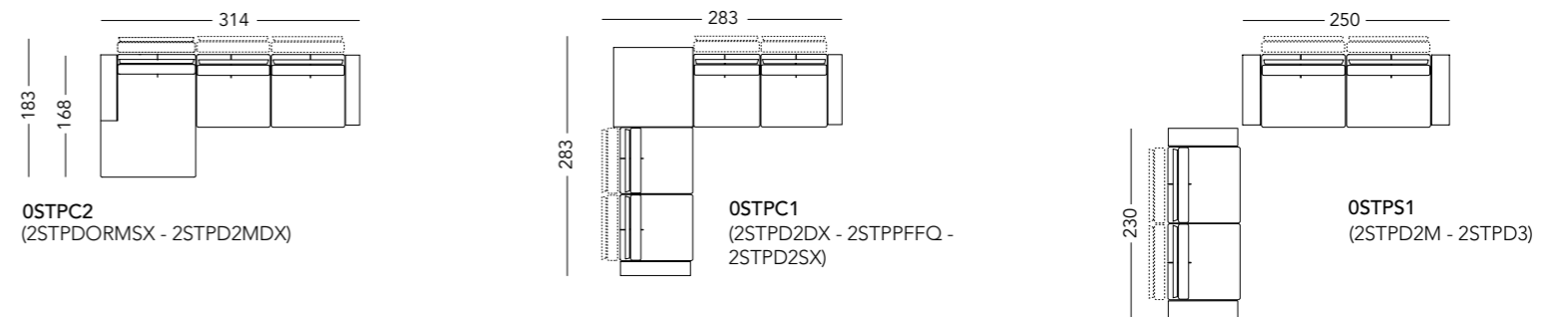

ELEMENTI / ELEMENTS / ELEMENTS / ELEMENTE

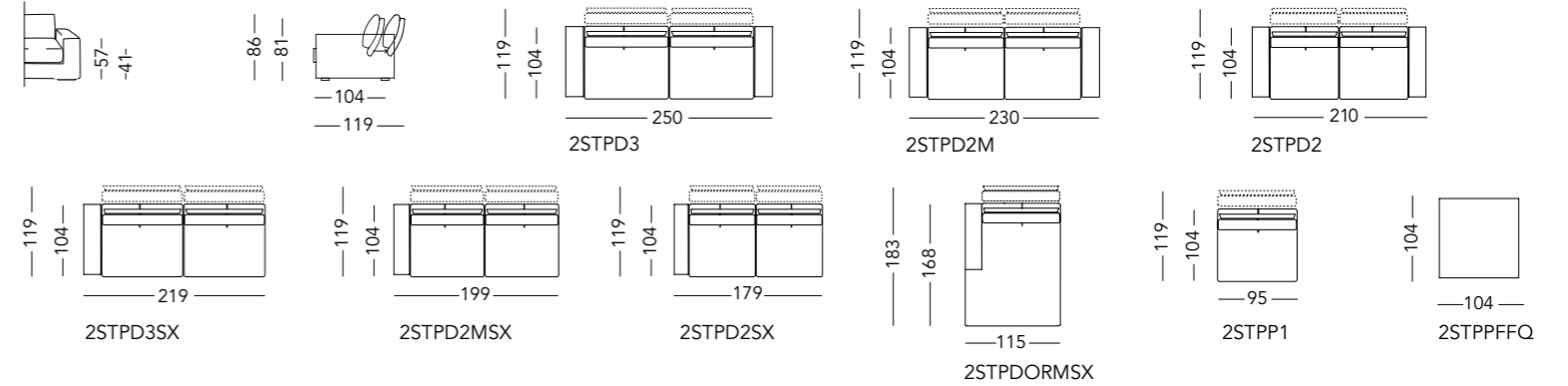

AVENUE

Tessuto | fabric | tissu | Stoff



COMPOSIZIONI / COMPOSITIONS / COMPOSITIONS / KOMPOSITIONEN

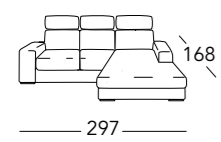

C1AVN
(D2MSXAVN - DORMDXAVN)

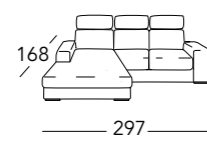

C2AVN
(D2MDXAVN - DORMSXAVN)

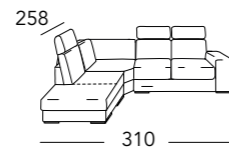

C3AVN
(D2MDXAVN - AA AVN - TSXAVN)

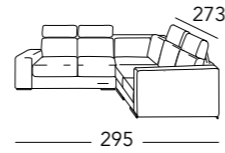

C4AVN
(D2MSXAVN - ANGDXAVN)

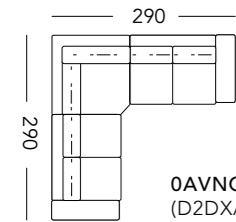

0AVNC5
(D2DXAVN - AA AVN - D2SXAVN)

ELEMENTI / ELEMENTS / ELEMENTS / ELEMENTE

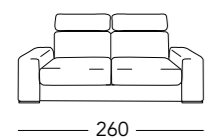
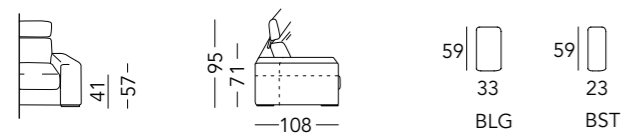

D3MAVN

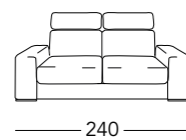

D3AVN

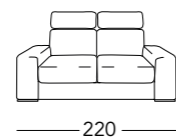

D2MAVN

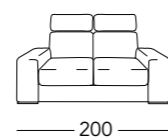

D2AVN

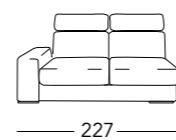

D3MSXAVN

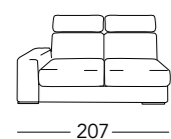

D3SXAVN

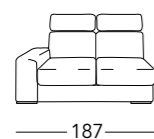

D2MSXAVN

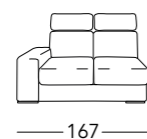

D2SXAVN

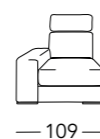

PSXAVN



P1AVN

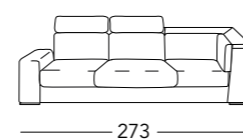

ANGSXAVN

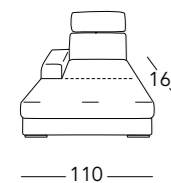

DORMSXAVN

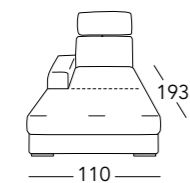

DORMXSXAVN

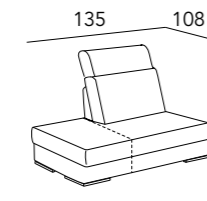

TSXAVN

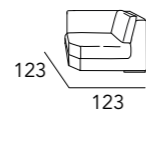

AA AVN

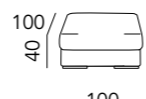

POUFFJAVN

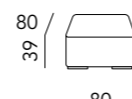

POUFFQAVN

AVENUE

Pelle | leather | cuir | Leder



COMPOSIZIONI / COMPOSITIONS / COMPOSITIONS / KOMPOSITIONEN

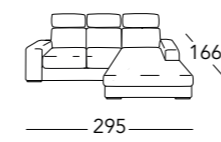

0AVPC1
(2AVPD2MSX - 2AVPDORMDX)

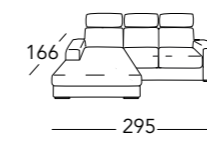

0AVPC2
(2AVPD2MDX - 2AVPDORMSX)

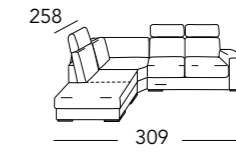

0AVPC3
(2AVPD2MDX - 2AVPAAP - 2AVPTRSX)

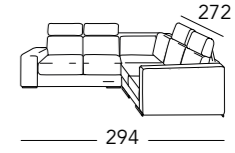

0AVPC4
(2AVPANGDX - 2AVPD2MSX)

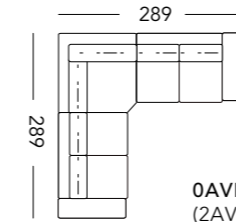

0AVPC5
(2AVPD2DX - 2AVPAAP - 2AVPD2SX)

ELEMENTI / ELEMENTS / ELEMENTS / ELEMENTE

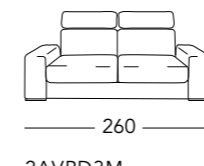
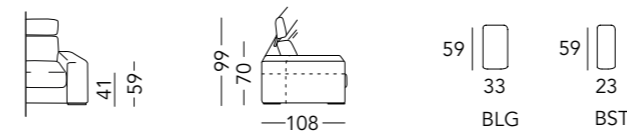

2AVPD3M

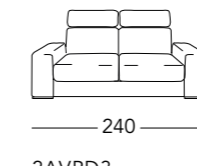

2AVPD3

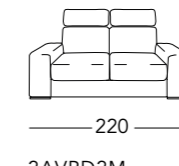

2AVPD2M

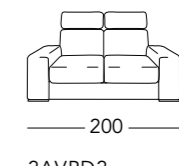

2AVPD2



2AVPD3MSX

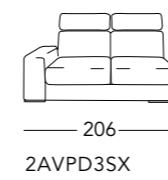

2AVPD3SX

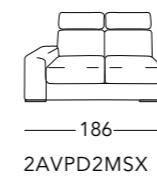

2AVPD2MSX

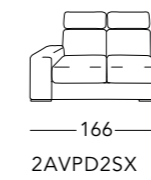

2AVPD2SX

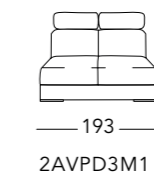

2AVPD3M1

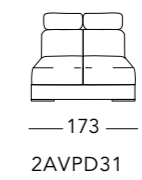

2AVPD31

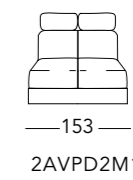

2AVPD2M1

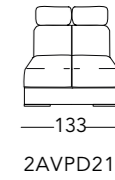

2AVPD21

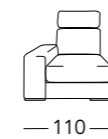

2AVPPSX

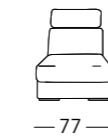

2AVPP1

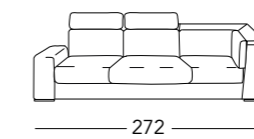

2AVPANGSX

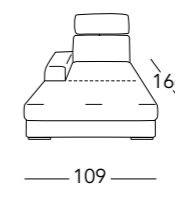

2AVPDORMSX

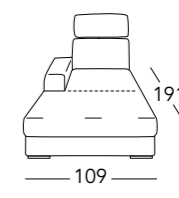

2AVPDORMSX

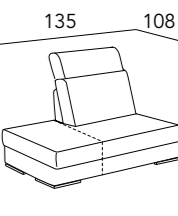

2AVPTRSX

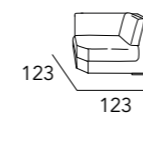

2AVPAAP

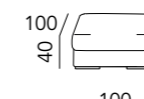
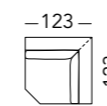

2AVPPFFJ

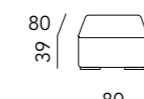

2AVPPF80

BEVERLY

Tessuto | fabric | tissu | Stoff



COMPOSIZIONI / COMPOSITIONS / COMPOSITIONS / KOMPOSITIONEN

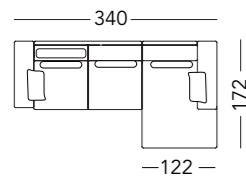

C1BLY
(D3SXBLEY - DORMDXBLEY
PTBLEY - 2 CBRBLEY)

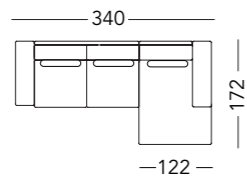

C2BLY
(D3SXBLEY - DORMDXBLEY)

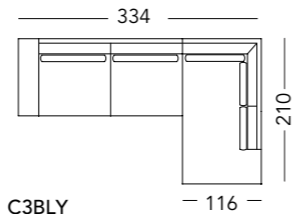

C3BLY
(D3SXBLEY - MERDXBLEY)

ELEMENTI / ELEMENTS / ELEMENTS / ELEMENTE

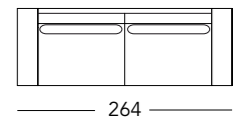
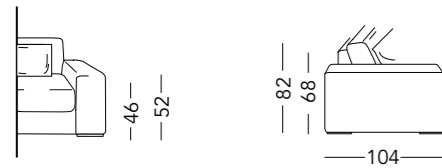

D3MBLY

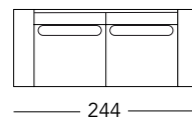

D3BLY

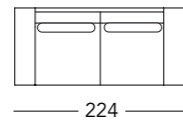

D2MBLY

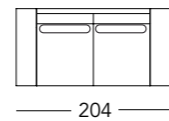

D2BLY

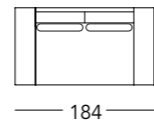

D2SBLY

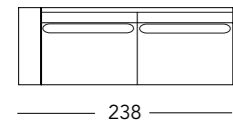

D3MSXBLY

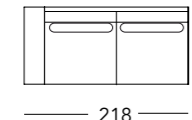

D3SXBLEY

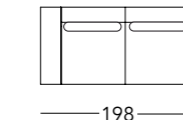

D2MSXBLY

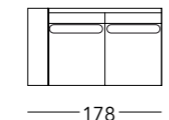

D2SXBLEY

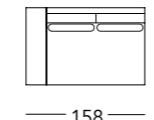

D2SSXBLY

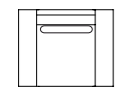

PBLEY

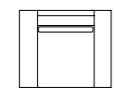

PSBLEY

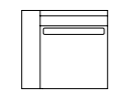

PSXBLY

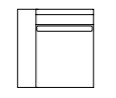

PSSXBLY



P1BLEY



PS1BLEY

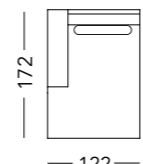

DORMSXBLEY

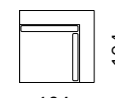

ARBLEY

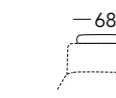

PTBLEY

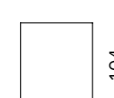

POUFFJBLY

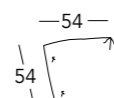

CBRBLEY

LUNA

Tessuto | fabric | tissu | Stoff



COMPOSIZIONI / COMPOSITIONS / COMPOSITIONS / KOMPOSITIONEN

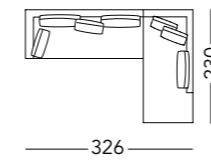

0LNAC1
(1LNAD3SX - 1LNATR3DX)

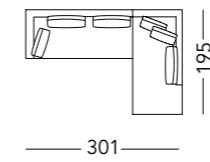

0LNAC2
(1LNAD2MSX - 1LNATR2MDX)

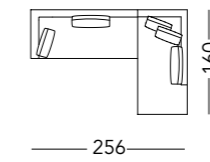

0LNAC3
(1LNAD2SX - 1LNATR2DX)

ELEMENTI / ELEMENTS / ELEMENTS / ELEMENTE

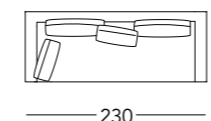
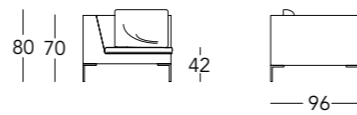

1LNAD3

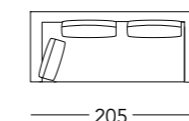

1LNAD2M

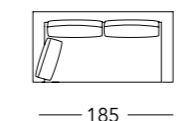

1LNAD2

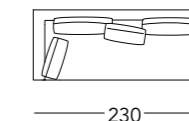

1LNAD3SX

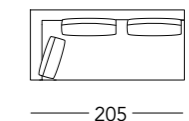

1LNAD2MSX

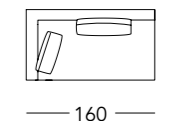

1LNAD2SX

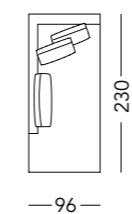

1LNATR3SX

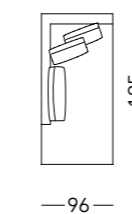

1LNATR2MSX



1LNATR2SX

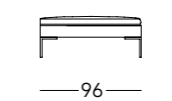

1LNAPFFQ

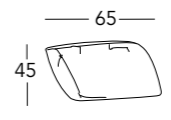

1LNACR65

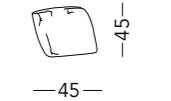

1LNACQ45

LUNA

Pelle | leather | cuir | Leder



COMPOSIZIONI / COMPOSITIONS / COMPOSITIONS / KOMPOSITIONEN

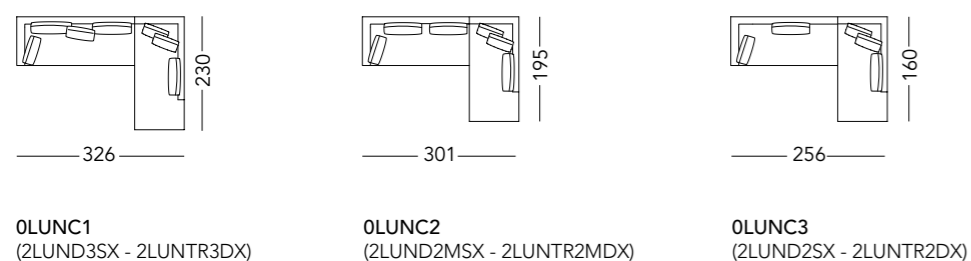

ELEMENTI / ELEMENTS / ELEMENTS / ELEMENTE

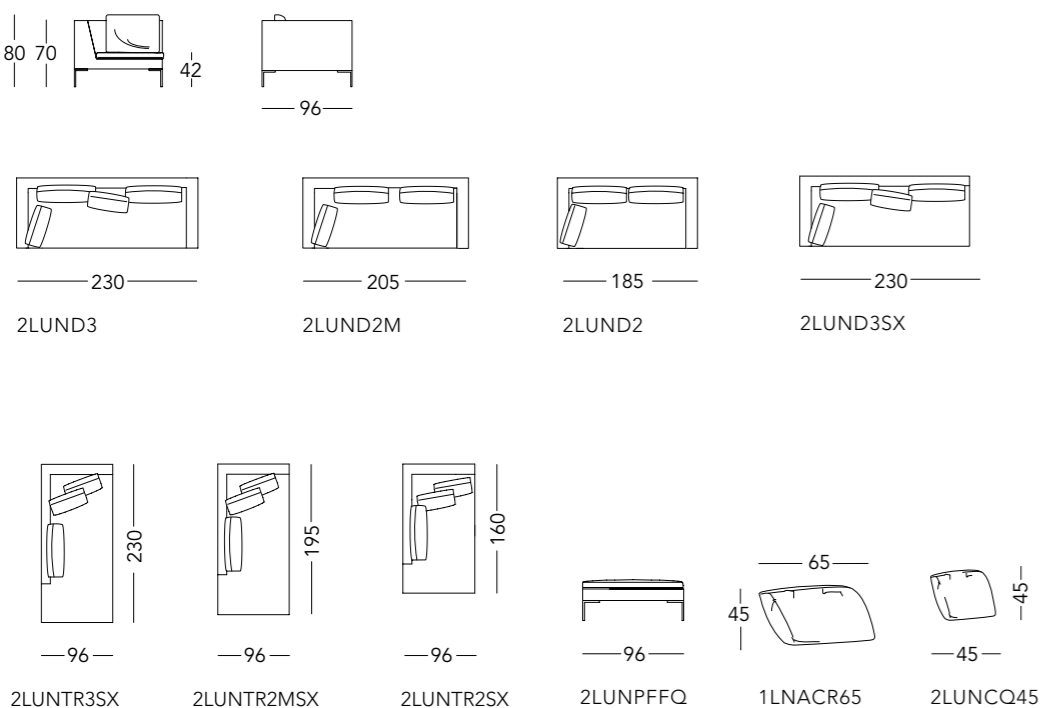

URBAN

Tessuto | fabric | tissu | Stoff



COMPOSIZIONI / COMPOSITIONS / COMPOSITIONS / KOMPOSITIONEN

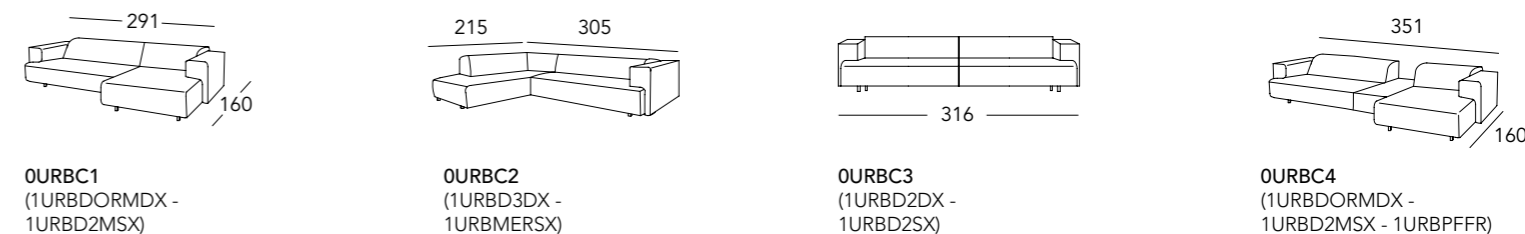

ELEMENTI / ELEMENTS / ELEMENTS / ELEMENTE

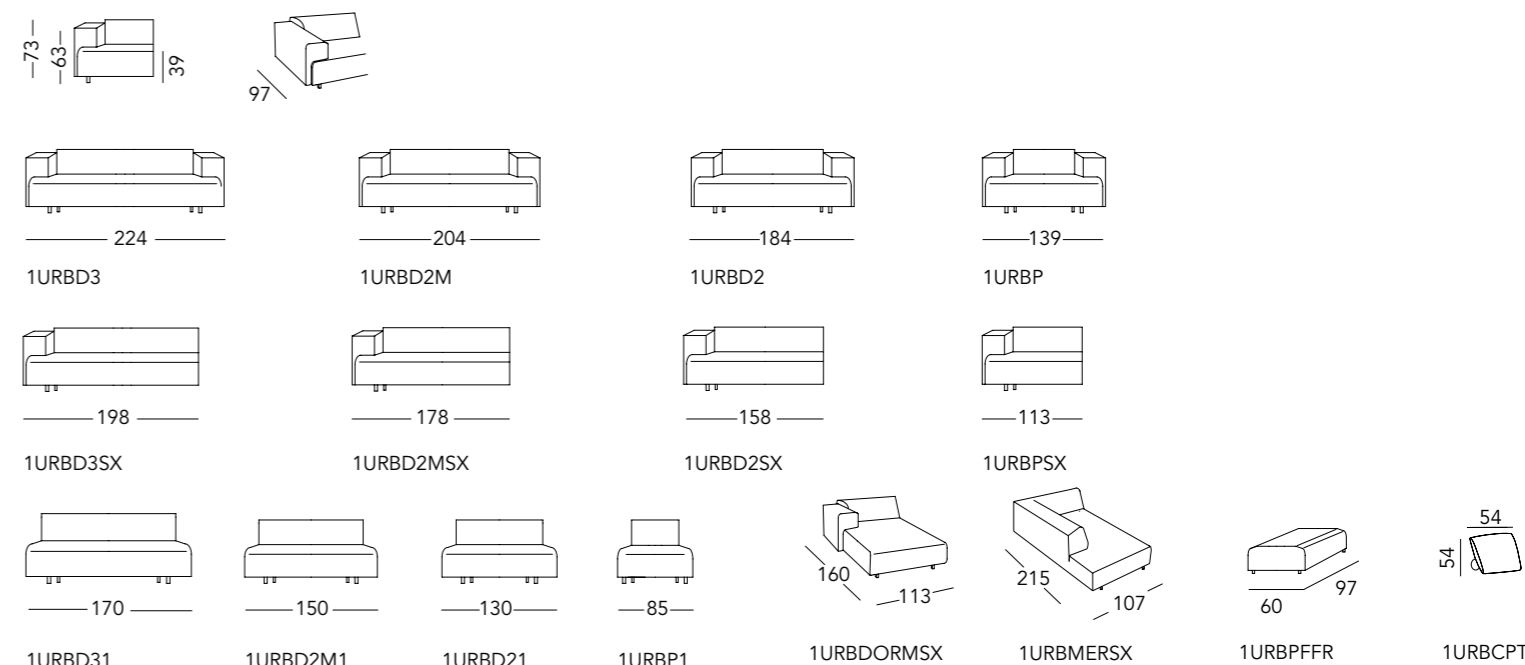

DALLAS

Tessuto | fabric | tissu | Stoff



COMPOSIZIONI / COMPOSITIONS / COMPOSITIONS / KOMPOSITIONEN

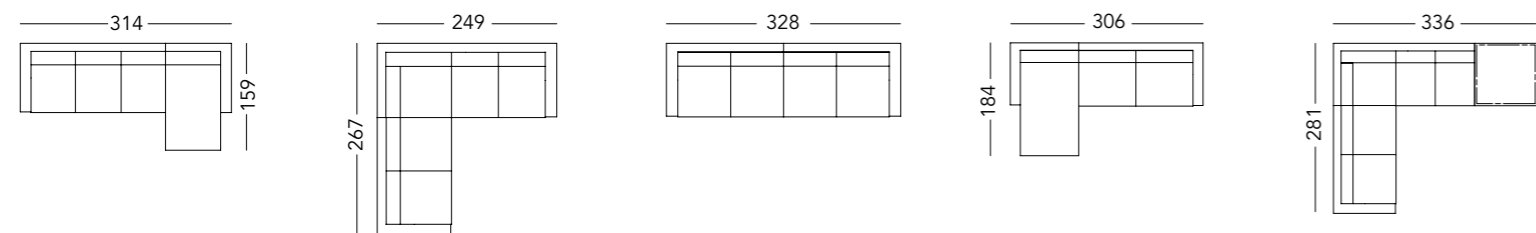

C1DLS (D3SXDL - DORMDXDL)
C2DLS (D2SXDL - ANGD3DXDL)
C3DLS (D2SXDL - D2DXDL)
C4DLS (D2LXDL - DORMSXDL)
C5DLS (D2MSXDL - TDSDL - POUFFQDL)

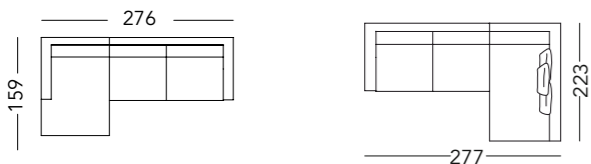

0DLSC6 (DORMSXDL - D2MDXDL)
0DLSC7 (D2MSXDL - 1DLSMERDX)

ELEMENTI / ELEMENTS / ELEMENTS / ELEMENTE

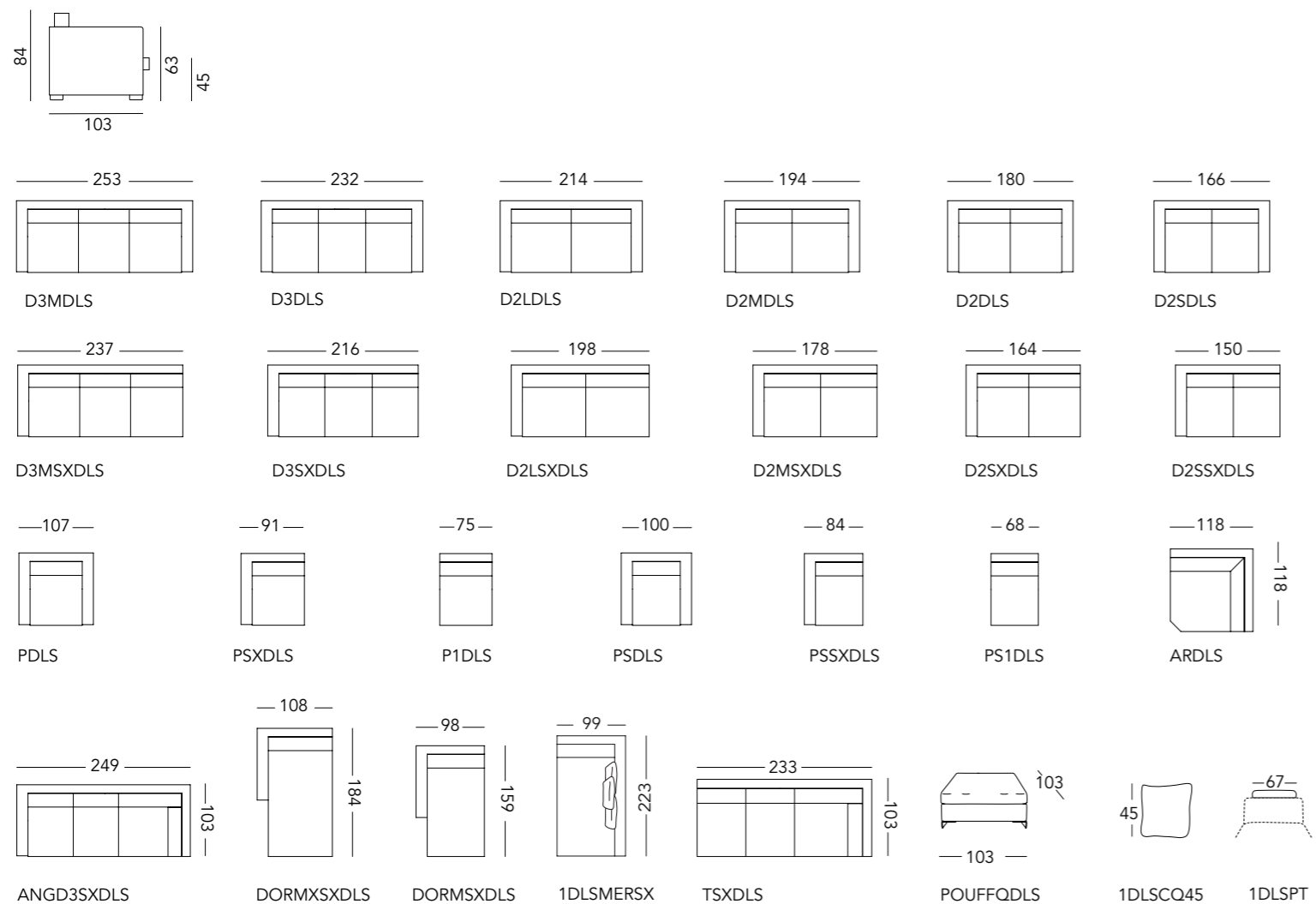

DALLAS

Pelle | leather | cuir | Leder



COMPOSIZIONI / COMPOSITIONS / COMPOSITIONS / KOMPOSITIONEN

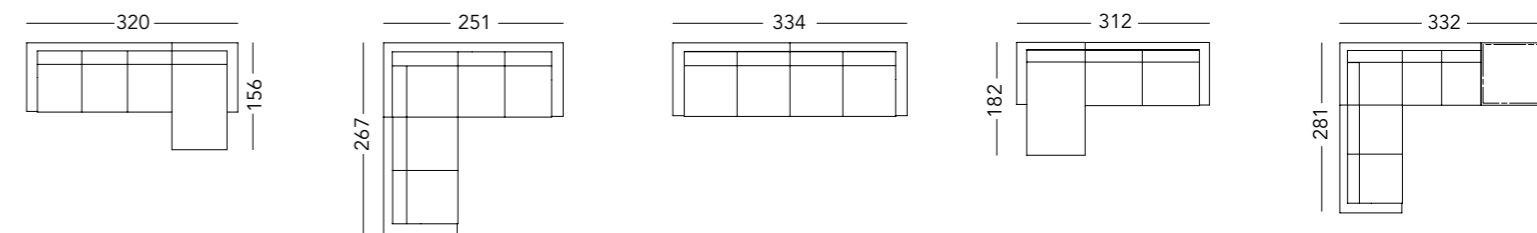

C1PDSP (D3SXPDSP - DORMDXPDSP)
C2PDSP (D2SXPDSP - ANGD3DXPDSP)
C3PDSP (D2SXPDSP - D2DXPDSP)
C4PDSP (D2LXPDSP - DORMSXPDSP)
C5PDSP (D2MSXPDSP - TDSP - POUFFQPDSP)

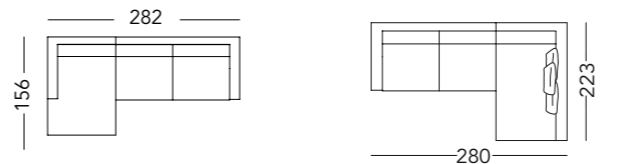

0DSPC6 (DORMSXPDSP - D2MDXPDSP)
0DSPC7 (D2MSXPDSP - 2DSPMERDX)

ELEMENTI / ELEMENTS / ELEMENTS / ELEMENTE

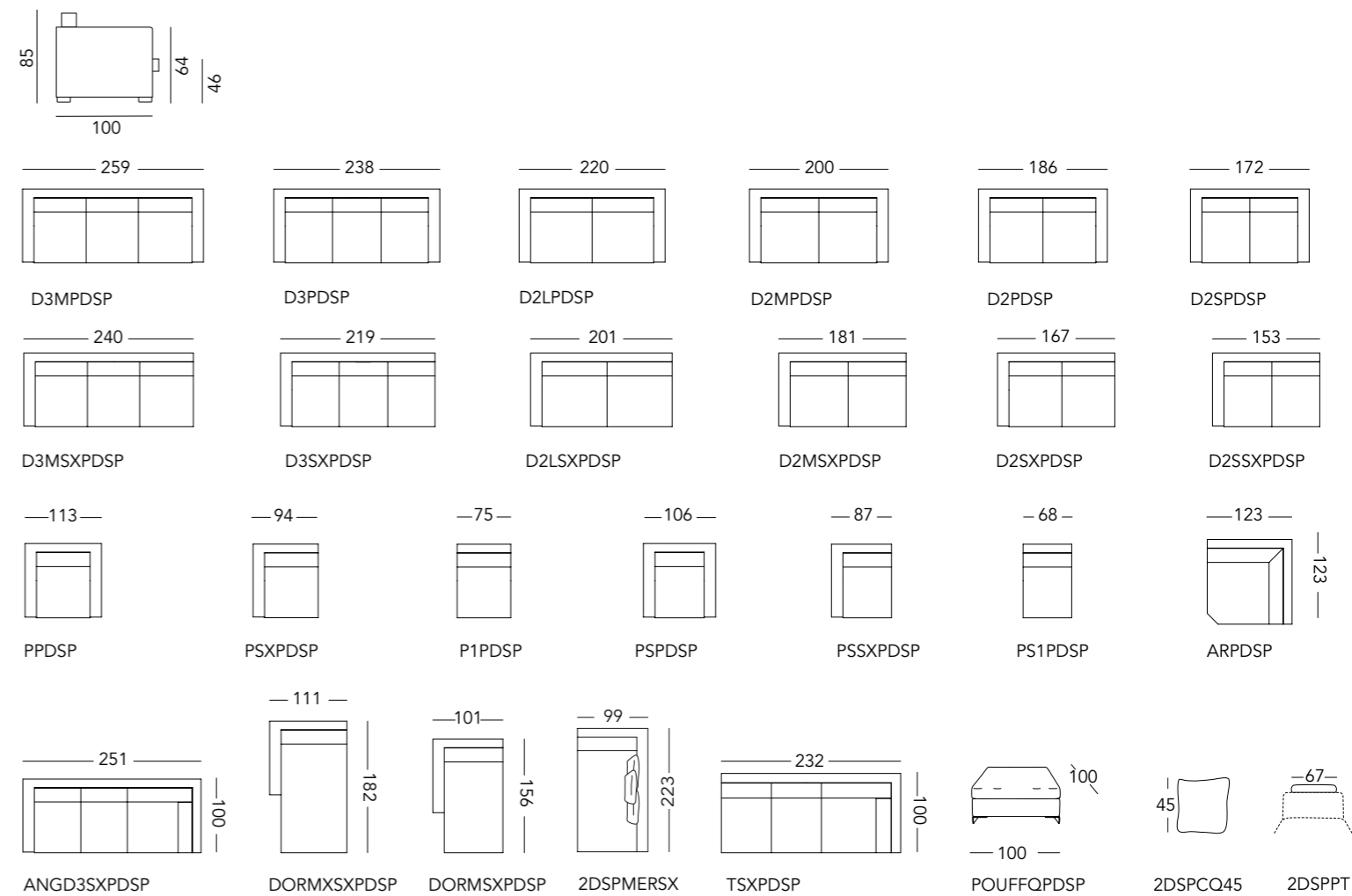













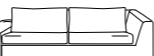

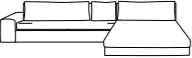
NEWPORT





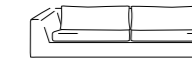
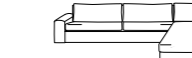
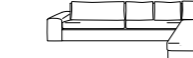











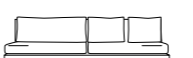

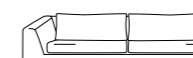



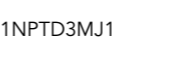



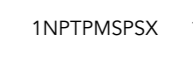

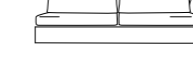
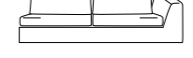

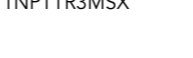
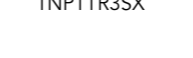
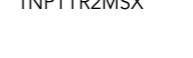
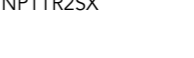

Tessuto | fabric | tissu | Stoff



COMPOSIZIONI / COMPOSITIONS / COMPOSITIONS / KOMPOSITIONEN

 — 297 — ONPTC1 (1NPTBR1SX - 1NPTTR3MSX)	 — 395 — ONPTC2 (1NPTBR1DX - 1NPTD3MJ1 - 1NPTDORM1)	 — 395 — ONPTC3 (1NPTBR1DX - 1NPTD3M1 - 1NPTDORM1)	 — 417 — ONPTC4 (1NPTBR1DX - 1NPTCHLSX - 1NPTD3M1)	 — 365 — ONPTC5 (1NPTBR1DX - 1NPTDORM1 - 1NPTD31)	 — 267 — ONPTC6 (1NPTBR1SX - 1NPTTR3SX)
 — 335 — ONPTC7 (1NPTBR1DX - 1NPTD2MJ1 - 1NPTDORM1)	 — 335 — ONPTC8 (1NPTBR1SX - 1NPTD2MJ1 - 1NPTDORM1)	 — 327 — ONPTC9 (1NPTBR1SX - 1NPTD2MJ1 - 1NPTDORS1 - 1NPTBR2DX)	 — 330 — ONPTC10 (1NPTBR1SX - 1NPTEJ - 1NPTD2MSX)	 — 433 — ONPTC11 (1NPTBR1SX - 1NPTP1 - 1NPTPFQ - 1NPTP1 - 1NPTEJ)	 — 395 — ONPTC12 (1NPTBR1SX - 1NPTD3M1 - 1NPTDORM1)
 — 254 — ONPTC13 (1NPTBR2DX - 1NPTD31 - 1NPTBR2SX)	 — 297 — ONPTC14 (1NPTBR1DX - 1NPTTR3MDX)	 — 314 — ONPTC15 (1NPTBR2DX - 1NPTDORS1 - 1NPTBR2SX - 1NPTD2M1)	 — 395 — ONPTC16 (1NPTBR1SX - 1NPTD3MJ1 - 1NPTDORM1)	 — 411 — — 297 — ONPTS1 (1NPTBR1DX - 1NPTTR3MDX - 1NPTP1 - 1NPTPFQ - 1NPTEJ)	

ELEMENTI / ELEMENTS / ELEMENTS / ELEMENTE









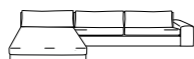

 — 240 — 1NPTD3M1	 — 210 — 1NPTD31	 — 180 — 1NPTD2M1	 — 150 — 1NPTD21	 — 120 — 1NPTPM1	 — 90 — 1NPTP1
 — 240 — 1NPTD3MJ1	 — 180 — 1NPTD2MJ1	 — 262 — 1NPTD3MSPSX	 — 232 — 1NPTD3SPSX	 — 202 — 1NPTD2MSPSX	 — 172 — 1NPTD2SPSX
 — 240 — 1NPTBR1SX	 — 180 — 1NPTBR2SX	 — 262 — 1NPTBR3SX	 — 232 — 1NPTBR4SX	 — 202 — 1NPTBR5SX	 — 172 — 1NPTBR6SX
 — 262 — 1NPTTR3MSX	 — 232 — 1NPTTR3SX	 — 202 — 1NPTTR2MSX	 — 172 — 1NPTTR2SX	 — 142 — 1NPTTRPMSX	 — 112 — 1NPTTRPSX
 — 262 — 1NPTANG3MSX	 — 232 — 1NPTANG3SX	 — 202 — 1NPTANG2MSX	 — 172 — 1NPTANG2SX		
 — 142 — 1NPTCHLSX	 — 112 — 1NPTCHLSSX	 — 120 — 1NPTDORM1	 — 90 — 1NPTDORS1		
 — 115 — 1NPTEJ	 — 103 — 1NPTPFQ	 — 35 — 1NPTBR1SX	 — 22 — 1NPTBR2SX	 — 67 — 1NPTPT	 — 60 — 1NPTCJ

NEWPORT

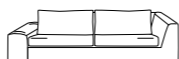

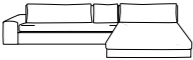

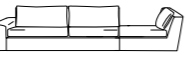

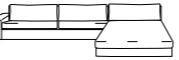
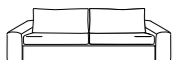
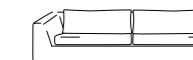
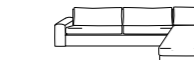
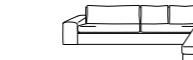
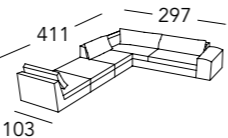



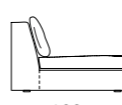

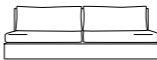





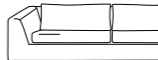
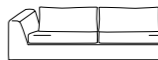

Pelle | leather | cuir | Leder

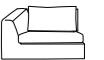

COMPOSIZIONI / COMPOSITIONS / COMPOSITIONS / KOMPOSITIONEN

 — 297 — C1PNWP (D3MDXSPNWP - BR1SXPNWP)	 — 395 — C2PNWP (D3MJ1PNWP - BR1DXPNWP - DORM1PNWP)	 — 395 — C3PNWP (D3M1PNWP - BR1DXPNWP - DORM1PNWP)	 — 417 — C4PNWP (D3M1PNWP - BR1DXPNWP - CHLSXPNWP)	 — 365 — C5PNWP (D31PNWP - BR1DXPNWP - DORM1PNWP)	 — 267 — C6PNWP (D3DXSPNWP - BR1SXPNWP)
 — 335 — C7PNWP (D2MJ1PNWP - BR1DXPNWP - DORM1PNWP)	 — 335 — C8PNWP (D2MJ1PNWP - BR1SXPNWP - DORM1PNWP)	 — 327 — C9PNWP (D2MJ1PNWP - BR1SXPNWP - DORMS1PNWP - BR2DXPNWP)	 — 330 — C10PNWP (D2M1PNWP - BR1SXPNWP - EJPNWP)	 — 433 — C11PNWP (P1PNWP - BR1SXPNWP - POUFFQPNWP - P1PNWP - EJPNWP)	 — 395 — C12PNWP (D3M1PNWP - BR1SXPNWP - DORM1PNWP)
 — 254 — C13PNWP (BR2SXPNWP - D31PNWP - BR2DXPNWP)	 — 297 — C14PNWP (D3MSXSPNWP - BR1DXPNWP)	 — 314 — C15PNWP (BR2SXPNWP - D2M1PNWP - DORMS1PNWP - BR2DXPNWP)	 — 395 — 0NWPC16 (BR1SXPNWP - DORM1PNWP - D3MJ1PNWP)	 — 411 — — 297 — — 103 — 0NWPS1 (BR1DXPNWP - POUFFQPNWP - EJPNWP - P1PNWP - D3MSXSPNWP)	

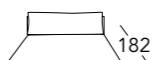
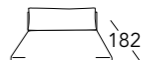
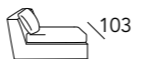
ELEMENTI / ELEMENTS / ELEMENTS / ELEMENTE

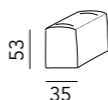
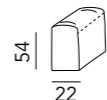
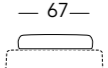
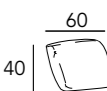
 — 40 — — 75 — — 103 — EJPNWP	 — 103 — POUFFQPNWP	 — 240 — D3M1PNWP	 — 210 — D31PNWP	 — 180 — D2M1PNWP	 — 150 — D21PNWP	 — 120 — PM1PNWP	 — 90 — P1PNWP
 — 240 — D3MJ1PNWP	 — 180 — D2MJ1PNWP	 — 262 — D3MSXSPNWP	 — 232 — D3SXPNWP	 — 202 — D2MSXSPNWP	 — 172 — D2SXPNWP	 — 142 — PMSXSPNWP	 — 112 — PSXSPNWP
 — 262 — ANG3MSXPNWP	 — 232 — ANG3SXPNWP	 — 202 — ANG2MSXPNWP	 — 172 — ANG2SXPNWP				
 — 142 — CHLSXPNWP	 — 112 — CHLSSXPNWP	 — 120 — DORM1PNWP	 — 90 — DORMS1PNWP				
 — 103 — EJPNWP	 — 103 — POUFFQPNWP	 — 53 — — 35 — BR1SXPNWP	 — 54 — — 22 — BR2SXPNWP	 — 67 — PTPNWP	 — 40 — — 60 — 2NWPCJ		

TOSCA

Tessuto | fabric | tissu | Stoff



COMPOSIZIONI / COMPOSITIONS / COMPOSITIONS / KOMPOSITIONEN

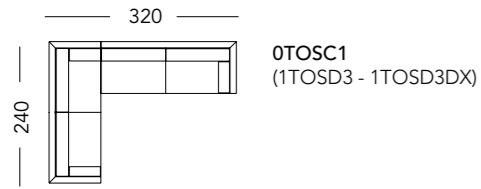

ELEMENTI / ELEMENTS / ELEMENTS / ELEMENTE

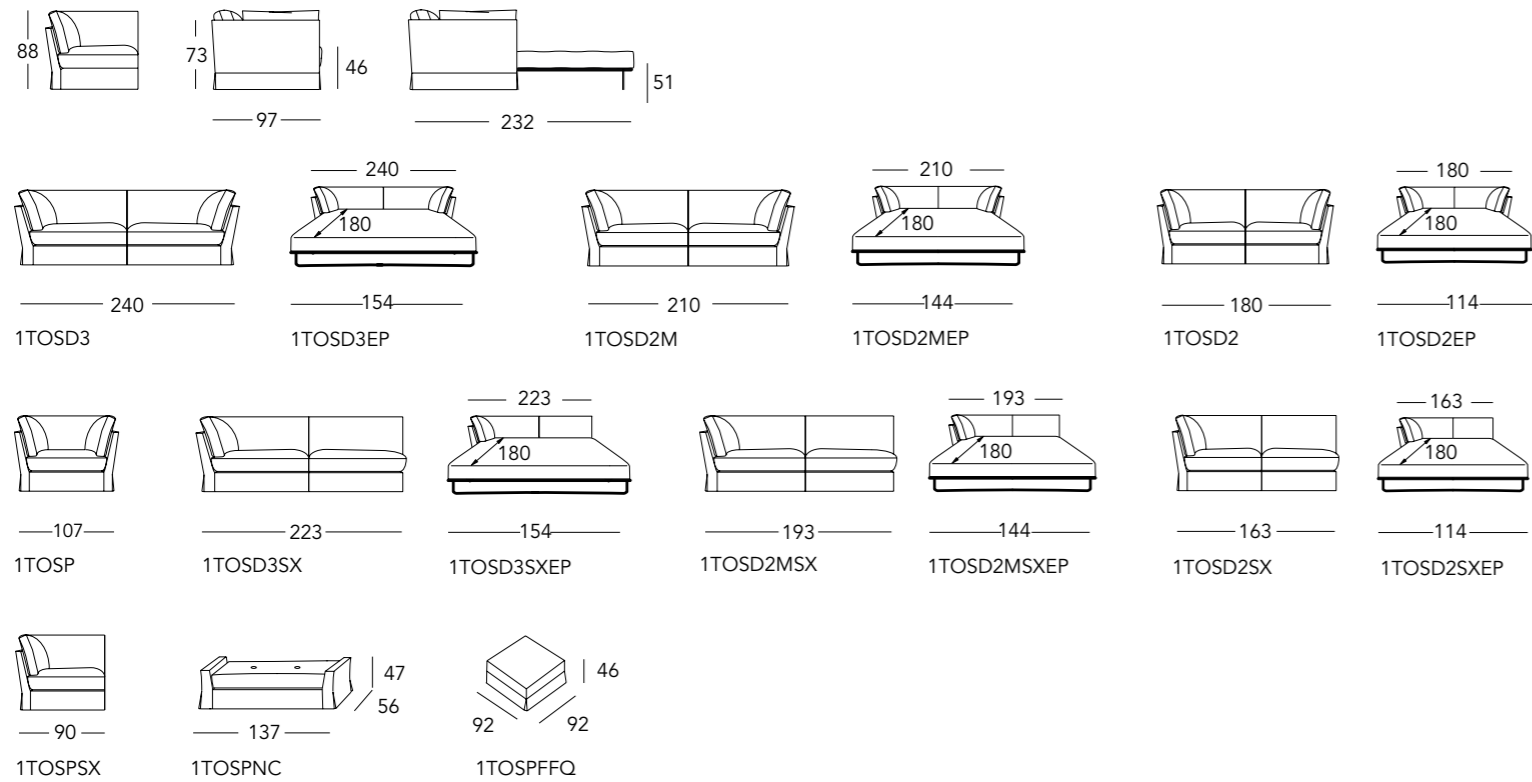

POUFF

Mod. 99 Tessuto | fabric | tissu | Stoff

ELEMENTI / ELEMENTS / ELEMENTS / ELEMENTE

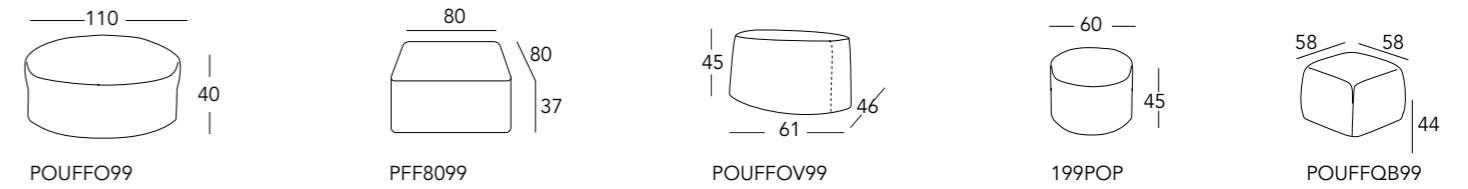

Mod. BABY Pelle | leather | cuir | Leder

ELEMENTI / ELEMENTS / ELEMENTS / ELEMENTE

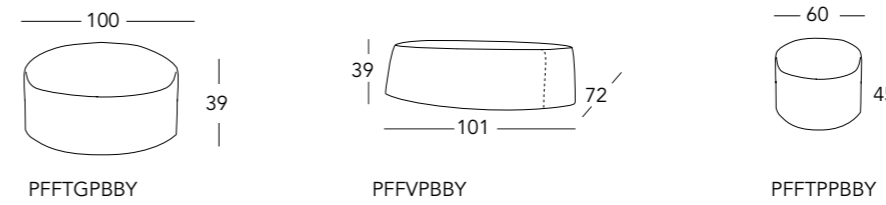

Mod. MORBIDOSO Tessuto | fabric | tissu | Stoff

ELEMENTI / ELEMENTS / ELEMENTS / ELEMENTE

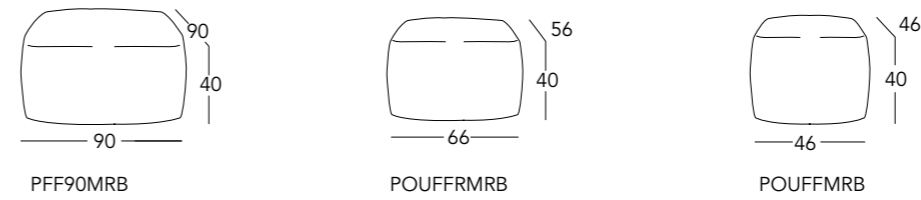

Mod. MORBIDOSO Pelle | leather | cuir | Leder

ELEMENTI / ELEMENTS / ELEMENTS / ELEMENTE

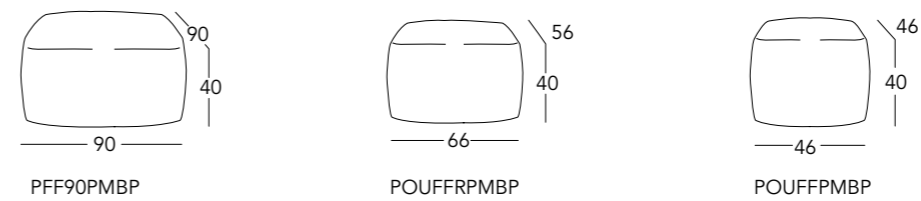

POUFFO99 - PFFTGPBBY PFF8099 POUFFOV99 199POP POUFFQB99
 PFFVPPBBY PFFTPPBBY PFF90MRB - PFF90PMBP POUFFMRB - POUFFPMBP POUFFMRB - POUFFPMBP

CUSCINI - Mod. 99

Tessuto | fabric | tissu | Stoff

ELEMENTI / ELEMENTS / ELEMENTS / ELEMENTE

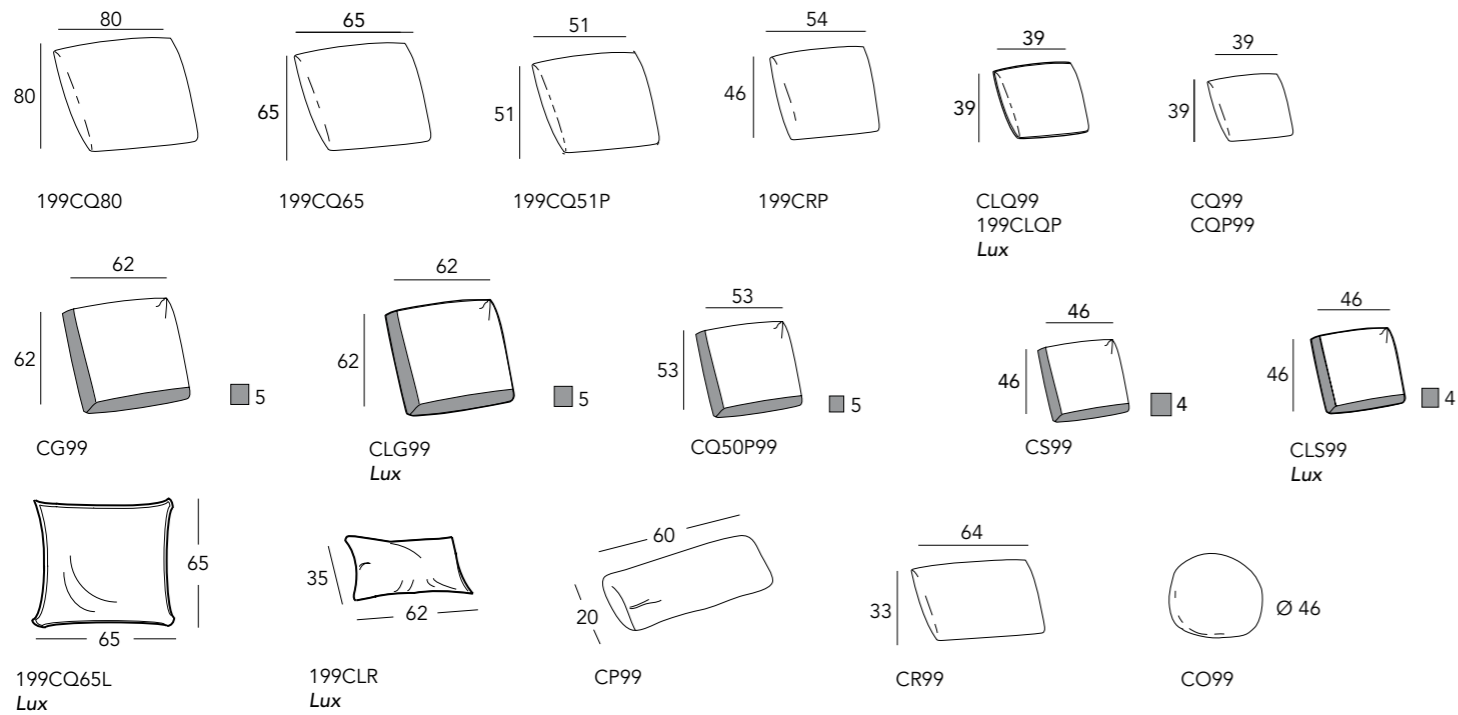

CUSCINI - Mod. 40

Pelle | leather | cuir | Leder

ELEMENTI / ELEMENTS / ELEMENTS / ELEMENTE

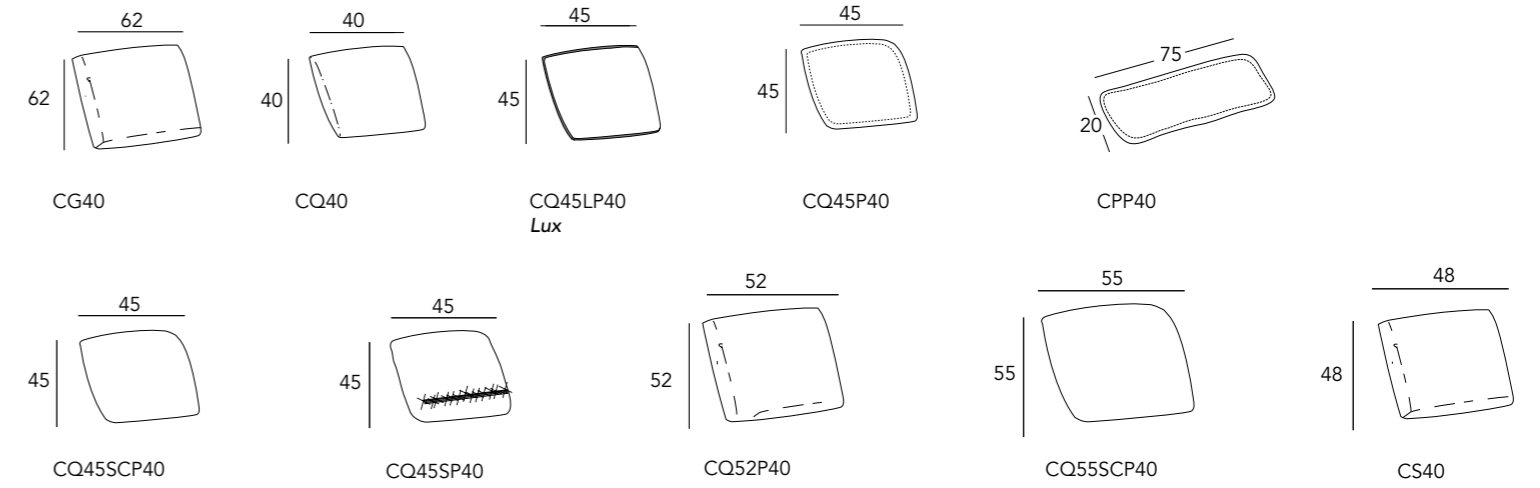

descrizioni tecniche

technical descriptions

alberta

STELLA | MOON

Struttura portante in massello di legno. Cuscino schienale in particelle di **lattice** e fibra di poliestere rivestito con fodera di cotone, cuscino di seduta in poliuretano espanso con imbottitura superiore in **piuma d'oca** e fibra di poliestere rivestito con fodera di cotone. **Meccanismo schienale in metallo zincato, permette l'avanzamento dello schienale.**

Main structure in solid wood. Backrest cushion in **latex** and polyester fibre covered with cotton covers, seat cushion in polyurethane foam with upper part in **goose feathers** and polyester fibre covered with cotton covers. **Backrest mechanism in galvanized metal.**

Structure principale en bois massif. Coussin de dossier en **latex** et fibre de polyester sous housse de coton, coussin d'assise en polyuréthane expansé partie supérieure en **plumes d'oie** et fibre de polyester sous housse de coton. **Mécanisme de dossier en métal galvanisé.**

Tragstruktur aus Massivholz. Rückenissen aus **Latexpartikeln** und Polyesterfasern mit Baumwolle Gewebe überzogen, Sitzkissen aus Polyurethanschaum aus **Gänsedaunen** und Polyesterfasern mit Baumwolle Gewebe überzogen. **Rückenlehne Mechanismus aus verzinktem Metall.**



AVENUE

Struttura portante in massello di legno. Cuscino di seduta in poliuretano espanso, cuscino di schienale in poliuretano espanso. Piedino realizzato in metallo cromato.

Main structure in solid wood. Seat cushion in polyurethane foam, backrest cushion in polyurethane foam. Chromium plated metal feet.

Carcasse principale en bois massif. Assise en polyuréthane expansé, dossier en polyuréthane expansé. Pied en métal chrome.

Struktur aus Massivholz (Schichtholz). Sitzkissen aus Polyurethanschaum, Rückenissen aus Polyurethanschaum. Füße aus Metall verchromt.



Cod. BST

Cod. BLG

BEVERLY

Struttura portante in massello di legno. Cuscino di seduta in poliuretano e **memory foam** con imbottitura superiore in **piuma d'oca** e fibra di poliestere rivestito con fodera di cotone; cuscino di schienale in **piuma d'oca** e fibra di poliestere rivestito con fodera di cotone. Piedino in inox satinato.

Main structure in solid wood. Seat cushion in polyurethane foam and **memory foam**, upper part with **goose feathers** and polyester fibre covered with cotton covers; backrest cushion in **goose feathers** and polyester fibre covered with cotton covers. Sanitized stainless steel feet.

Structure principale en bois massif. Coussin d'assise en polyuréthane expansé et **memory foam**, partie supérieure en **plumes d'oie** et fibre de polyester sous housse de coton; coussin de dossier en **plumes d'oie** et fibre de polyester sous housse de coton. Pieds en acier inox.

Tragstruktur aus Massivholz. Sitzkissen aus Polyurethanschaum und **Memory Foam** Oberteil aus **Gänsedaunen** und Polyesterfasern, Abgedeckt mit Baumwolle; Rückenissen aus **Gänsedaunen** und Polyesterfasern, Abgedeckt mit Baumwolle. Rostfrei Stahl Füße.





LUNA

Struttura portante in massello di legno. Cuscino di seduta in poliuretano espanso, cuscino di schienale in **piuma d'oca** e fibra di poliestere rivestito con fodera di cotone. Piedino realizzato in metallo cromato.

*Main structure in solid wood. Seat cushion in polyurethane foam, backrest cushion in **goose feathers** and polyester fibre covered with cotton covers. Chromium plated metal feet.*

*Carcasse principal en bois massif. Assise en polyuréthane expansé, dossier en **plumes d'oie** et fibre de polyester sous housse de coton. Pied en métal chrome.*

*Struktur aus Massivholz (Schichtholz). Sitzkissen aus Polyurethanschaum, Rückenkissen aus **Gänsedaunen** und Polyesterfasen, Abgedeckt mit Baumwolle. Füße aus Metall verchromt.*



URBAN

Struttura portante in massello di legno. Cuscino di seduta in poliuretano espanso, schienale in poliuretano espanso. Molleggio realizzato con molle in acciaio tipo **Nosag**.

*Main structure in solid wood. Seat cushion in polyurethane foam, backrest in polyurethane foam. **Nosag** springs.*

*Carcasse principal en bois massif. Assise en polyuréthane expansé, dossier en polyuréthane expansé. Ressorts en métal (**Nosag**).*

*Struktur aus Massivholz (Schichtholz). Sitzkissen aus Polyurethanschaum, Rücklehne aus Polyurethanschaum. Stahlfedern **Nosag**.*



DALLAS

Struttura portante in massello di legno. Cuscino di seduta in poliuretano espanso con imbottitura superiore in **piuma d'oca** e fibra di poliestere rivestito con fodera di cotone; cuscino di schienale in **particelle di lattice** e fibra di poliestere rivestito con fodera di cotone. Piedino in alluminio lucido.

*Main structure in solid wood. Seat cushion in polyurethane foam with upper part with **goose feathers** and polyester fibre covered with cotton covers; backrest cushion in **latex** and polyester fibre covered with cotton covers. Aluminium glossy feet.*

*Structure principal en bois massif. Coussin d'assise en polyuréthane expansé, partie supérieure en **plumes d'oie** et fibre de polyester sous housse de coton; coussin de dossier en **latex** et fibre de polyester sous housse de coton. Pieds en aluminium brillant.*

*Tragstruktur aus Massivholz. Sitzkissen aus Polyurethanschaum Oberteil aus **Gänsedaunen** und Polyesterfasen, Abgedeckt mit Baumwolle; Rückenkissen aus **Latexpartikeln** und Polyesterfasen, Abgedeckt mit Baumwolle. Füße aus poliert Aluminium.*

Cod. 480

Cod. 183

NEWPORT

Struttura portante in massello di legno. Cuscino di seduta in poliuretano espanso con imbottitura superiore in **piuma d'oca** e fibra di poliestere rivestito con fodera di cotone; cuscino di schienale in **piuma d'oca** e fibra di poliestere rivestito con fodera di cotone.

*Main structure in solid wood. Seat cushion in polyurethane foam with upper part with **goose feathers** and polyester fibre covered with cotton covers; backrest cushion in **goose feathers** and polyester fibre covered with cotton covers.*

*Structure principal en bois massif. Coussin d'assise en polyuréthane expansé, partie supérieure en **plumes d'oie** et fibre de polyester sous housse de coton; coussin de dossier en **plumes d'oie** et fibre de polyester sous housse de coton.*

*Tragstruktur aus Massivholz. Sitzkissen aus Polyurethanschaum Oberteil aus **Gänsedaunen** und Polyesterfasen, Abgedeckt mit Baumwolle; Rückenkissen aus **Gänsedaunen** und Polyesterfasen, Abgedeckt mit Baumwolle.*



TOSCA

Struttura portante in massello di legno. Cuscino di seduta in poliuretano espanso con imbottitura superiore in **piuma d'oca** e fibra di poliestere rivestito con fodera di cotone; cuscino di schienale in **piuma d'oca** e fibra di poliestere rivestito con fodera di cotone.

*Main structure in solid wood. Seat cushion in polyurethane foam with upper part with **goose feathers** and polyester fibre covered with cotton covers; backrest cushion in **goose feathers** and polyester fibre covered with cotton covers.*

*Structure principal en bois massif. Coussin d'assise en polyuréthane expansé, partie supérieure en **plumes d'oie** et fibre de polyester sous housse de coton; coussin de dossier en **plumes d'oie** et fibre de polyester sous housse de coton.*

*Tragstruktur aus Massivholz. Sitzkissen aus Polyurethanschaum Oberteil aus **Gänsedaunen** und Polyesterfasen, Abgedeckt mit Baumwolle; Rückenkissen aus **Gänsedaunen** und Polyesterfasen, Abgedeckt mit Baumwolle.*



COMPANY PROFILE

Il marchio ALBERTA da trent'anni rappresenta garanzia di qualità nella progettazione e nella produzione di divani e poltrone. L'azienda opera nel trevigiano, nord-est Italia, dal cui sostrato culturale ha attinto sia la tradizione artigiana sia l'attitudine alla creatività ed al design. Nel corso della sua storia ha sviluppato nei diversi stabilimenti linee di imbottiti sempre rispondenti all'evoluzione del gusto nelle due divisioni base che raggruppano le collezioni in tessuto e quelle in pelle. L'esperienza nell'impiego di entrambi i materiali consente ad Alberta di essere altamente propositiva. L'obiettivo dell'azienda è offrire soluzioni originali di ottimo livello estetico, pratico e qualitativo nel rispetto dei principi dell'etica ambientale.

For thirty years the ALBERTA brand has been recognised as a guarantee of quality in the design and production of sofas and armchairs. The company is headquartered in the Province of Treviso in the north east of Italy and has taken both its tradition of fine craftwork and its passion for creativity and design from this stimulating and active land. In order to meet the needs of ever-changing tastes the company has developed and now manufactures an extensive range of products based on two basic divisions, their textile and leather furniture collections. The experience they have gained working with these materials enables Alberta to be proactive and continually develop new solutions. The company mission is to create original products which combine great looks with practicality and quality while ensuring the utmost respect for the environment.

Le marque ALBERTA depuis 30 ans c'est une garantie de qualité dans la projection et fabrication de fauteuils et canapés. L'usine opère dans la province de Treviso, nord-est de l'Italie, et du substrat culturel de cette zone elle a pris soit la tradition artisanale soit la disposition à la créativité et au design. Au cours de l'histoire elle a développé dans les différents usines des lignes des canapés toujours correspondant à l'évolution du goût dans les deux collections en cuir et tissu. L'expérience dans l'utilisations des matériaux a permis à Alberta d'être bien propositive avec ces collections. L'objectif de l'usine est offrir solutions originales de niveau esthétique, pratique et qualitatif excellent dans le respect des principes de l'éthique de l'ambiance.

Die Marke ALBERTA steht seit dreißig Jahren als Garantie für Qualität in der Entwicklung und Herstellung von Sofas und Sesseln. Das Unternehmen hat seinen Hauptsitz in der Provinz Treviso, im Nordosten Italiens. Angeregt von dieser Kultur und Landschaft schöpft Alberta sowohl aus der handwerklichen Tradition als auch aus der Begabung und Leidenschaft für Kreativität und Design. Im Laufe seiner Geschichte hat das Unternehmen in seinen verschiedenen Betrieben eine breite Palette von Polstermöbel entwickelt, die den Bedürfnissen der Kunden entgegenkommt. Dabei sind zwei grundlegende Richtungen entstanden: die Stoff- und die Lederkollektion. Die gewonnenen Erfahrungen in der Verwendung mit beiden Materialien ermöglicht Alberta sehr aktiv zu sein und ständig neue Lösungen zu entwickeln. Das Unternehmen hat sich zum Ziel gesetzt, originelle Lösungen mit hohen ästhetischen, praktischen und qualitativen Niveau anzubieten und gleichzeitig umweltfreundlich zu sein.

La riproduzione totale o parziale è permessa esclusivamente su nostra autorizzazione.

Le immagini e i disegni contenuti nel presente catalogo sono puramente rappresentativi di questo prodotto e possono subire variazioni e modifiche anche senza preavviso.

Pertanto nella scelta degli articoli per la compilazione dell'ordine, fa fede solamente quanto contenuto nel listino in vigore.

Reproduction, total or partial, is allowed exclusively under licence from our company. The photographs and drawings in this catalogue are only a representation of products and may be varied and changed without notice. When choosing article for your orders, only the details contained in the price-list in force should be considered.

La reproduction totale ou partielle est soumise exclusivement à notre autorisation. Les images et les dessins présents dans ce catalogue sont uniquement des représentations de ce produit et peuvent subir des variations et des modifications même sans préavis. Par conséquent, une fois les articles choisis, lorsque vous remplirez le bon de commande, référez-vous au tarif en vigueur car il est le seul à faire foi.

Die Teilweise oder Gesamte Wiedergabe ist Ausschließlich mit unserer Erlaubnis gestattet. Hinweis: Alle in diesem Katalog enthaltenen Abbildungen sind unverbindlich; wir behalten uns das Recht vor, Änderungen oder Verbesserungen ohne Ankündigung durchzuführen. Maßgeblich für die Auswahl der einzelnen zu bestellenden Produkte ist ausschließlich die jeweils gültige Verkaufspreisliste.

Photo: Fotorama
Renai&Renai

Design: Caseley Giovana

Art direction: Ufficio Stile Alberta Pacific Furniture

Printed in Italy by:

alberta[®]
The first name in Italian sofas

Alberta Pacific Furniture S.p.A.
Via Toniolo, 41
31028 Vazzola (TV) Italy
Tel. +39 0438 440440
Fax +39 0438 441555
email: contact@albertasalotti.it

www.alberta.it

alberta[®]
The first name in Italian sofas

MOON STELLA	06
AVENUE	24
BEVERLY	36
LUNA	48
URBAN	56
DALLAS	64
NEWPORT	78
TOSCA	92
POUFF	98
MORBIDOSO 99 BABY	
CUSCINI	110